

RADIO'S GREATEST MAGAZINE

January

25 Cents

In United States
and Canada

OVER 175 ILLUSTRATIONS

Jan. '39

HUGO
GERNSBACK
EDITOR

Radio-Craft

TERRY-HOLDEN
JUNGLE EXPEDITION

See Page 392



Announcing: The "Average American Home"—Wired for Radio! • Ballast Tubes
"Farmer's Friend" 1½-V. Battery Set • Making a Plug-Together A.C. Radio Set

OVER 50,000 RADIO MEN READ RADIO-CRAFT MONTHLY

**CHANNEL TESTING
DYNAMIC TESTING
STAGE BY STAGE**

**NO MATTER HOW
YOU TEST . . . you
need an oscillator that**

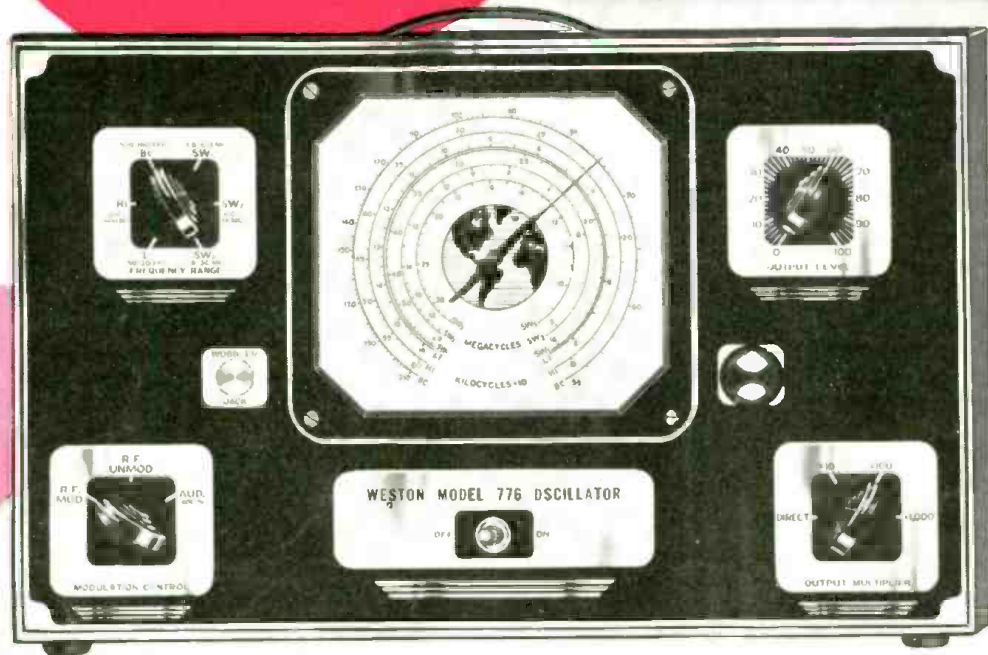

*won't
drift!*

**Here's the Oscillator with
automatic amplitude control and hand calibrated
dial . . . that doesn't drift,
that's guaranteed to hold
its accuracy.**

only **\$65²⁵**
NET

TO SERVICEMEN IN U.S.A.

WESTON

DIRECT READING OSCILLATOR

See this Model 776 Oscillator at your jobber's today,
as well as the inexpensive WESTON Vacuum Tube Volt-
meter. Or, return coupon immediately for complete
information.

Weston Electrical Instrument Corporation,
599 Frelinghuysen Ave., Newark, N. J.

Send literature describing Model 776 Oscillator and 669 Vacuum
Tube Voltmeter

Name.....

Address.....

City..... State.....



J. E. SMITH, President
NATIONAL RADIO INSTITUTE
 Established 1914

The man who has directed the home study training of more men for the Radio Industry than any other man in America.



Broadcasting Stations

Employ managers, engineers, operators, installation and maintenance men for fascinating jobs and pay up to \$5,000 a year.



Repairing Radio Sets

Spare time set repair work pays many \$5, \$10, \$15 a week extra while learning. Full time servicing pays as much as \$30, \$50, \$75 a week.

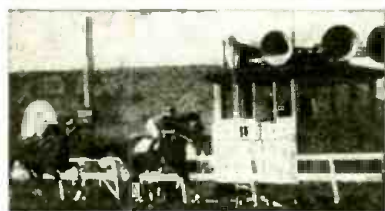

Loud Speaker Systems

Building, installing, servicing and operating public address systems is another growing field for men well trained in Radio.

Lesson on Radio Servicing Tips FREE

I'll prove my Training gives practical, money-making information, is easy to understand—just what you need to master Radio. My simple lesson text, "Radio Receiver Troubles—Their Cause and Remedy" covers a long list of Radio receiver troubles in A.C., D.C., battery, universal, auto, T.H.F., superheterodyne, all-wave, and other types of sets. A cross reference gives you the probable cause and a quick way to locate and remedy these set troubles. A special section is devoted to receiver check-up, alignment, balancing, neutralizing and testing. You can get this lesson Free. No obligation.



MAIL COUPON NOW

The Tested Way to BETTER PAY

I will send you a Lesson Free
to show how I train you
at home in spare time
for Good Jobs in Radio

Clip the coupon and mail it. I will prove I can train you at home in your spare time to be a RADIO EXPERT. I will send you my first lesson FREE. Examine it, read it, see how easy it is to understand—how practical I make learning Radio at home. Men without Radio or electrical knowledge become Radio Experts, earn more money than ever as a result of my Training.

Get Ready Now for Jobs Like These

Radio broadcasting stations employ engineers, operators, station managers and pay up to \$5,000 a year. Fixing Radio sets in spare time pays many \$200 to \$500 a year—full time jobs with Radio jobbers, manufacturers and dealers as much as \$30, \$50, \$75 a week. Many Radio Experts open full or part time Radio sales and repair businesses. Radio manufacturers and jobbers employ testers, inspectors, foremen, engineers, servicemen, and pay up to \$6,000 a year. Automobile, police, aviation, commercial Radio, loud speaker systems are newer fields offering good opportunities now and for the future. Television promises to open many good jobs soon. Men I trained have good jobs in these branches of Radio. Read how they got their jobs. Mail coupon.

Why Many Radio Experts Make \$30, \$50, \$75 a Week

Radio is young—yet it's one of our large industries. More than 28,000,000 homes have one or more Radios. There are more Radios than telephones. Every year millions of Radios get out of date and are replaced. Millions more need new tubes, repairs. Over \$50,000,000 are spent every year for Radio repairs alone. Over 5,000,000 auto Radios are in use; more are being sold every day, offering more profit-making opportunities for Radio experts. And RADIO IS STILL, YOUNG, GROWING, expanding into new fields. The few hundred \$30, \$50, \$75 a week jobs of 20 years ago have grown to thousands. Yes, Radio offers opportunities—now and for the future!

Many Make \$5, \$10, \$15 a Week Extra in Spare Time While Learning

The day you enroll, in addition to our regular Course, I start sending Extra Money Job Sheets, show you how to do Radio repair jobs. Throughout your training I send plans and directions that make good spare time money—\$200 and \$300—for hundreds, while learning. I send you special Radio equipment—to conduct experiments, build circuits. This 50-50 method of training makes learning at home easy, fascinating, practical.

I Also Give You This Professional Servicing Instrument



Here is the instrument every Radio expert needs and wants—an All-Wave, All-Purpose, Set Servicing Instrument. It contains everything necessary to measure A.C. and D.C. voltages and current; to test tubes, resistance; adjust and align any set, old or new. It satisfies your needs for professional servicing after you graduate—can help you make extra money fixing sets while training.

Get Sample Lesson and 64 Page Book Mail Coupon

Act Today. Mail the coupon now for sample lesson and 64-page book. They're free to any fellow over 16 years old. They point out Radio's spare time and full time opportunities and those coming in Television; tell about my training in Radio and Television; show you letters from men I trained, telling what they are doing and earning. Find out what Radio offers YOU! MAIL COUPON in an envelope, or paste on a postcard—NOW!

J. E. Smith, President
 Dept. 9AX
 National Radio Institute
 Washington, D. C.

HERE'S PROOF



\$10 a Week in Spare Time

Address systems work all in my spare time. My earnings in Radio amount to about \$10 a week.—WILLIAM MEYER, 705 Ridge Road, Hobart, Ind.



Earnings Tripled by N. R. I. Training

"I have been doing nicely, thanks to N. R. I. Training. My present earnings are about three times what they were before I took the Course. I consider N. R. I. Training the finest in the world."—BERNARD COSTA, 952 Manhattan Ave., Brooklyn, N. Y.



Good for **FREE SAMPLE LESSON and BOOK on RADIO'S OPPORTUNITIES**

J. E. SMITH, President
 National Radio Institute, Dept. 9AX
 Washington, D. C.

Dear Mr. Smith: Without obligation send me free the Sample Lesson and your 64-Page Book "Rich Rewards in Radio," telling about spare time and full time Radio opportunities, and how I can train for them at home in spare time. (Please write plainly)

Name Age

Address

City State

14X-1

Please Say That You Saw It in RADIO-CRAFT

Radio-Craft

FOR THE
SERVICE MAN · DEALER · RADIOTRICIAN

HUGO GERNSBACK, *Editor-in-Chief*

N. H. LESSEM
Associate Editor

THOS. D. PENTZ
Art Director

ROBERT EICHBERG
Trade Digest Editor

R. D. WASHBURNE, *Managing Editor*

Contents JANUARY, 1939 Issue

VOLUME X -- NUMBER 7

Editorial: The Television Racket.....	Hugo Gernsback	389
The Radio Month in Review.....		390
The Terry-Holden Jungle Expedition.....		392
Marconi—Father of Radio?.....	Edward H. Loftin	393
Radio Altimeter Increases Air Safety.....	R. D. Washburne	394
This Home—"Wired for Radio"—Part I.....	N. H. Lessem	396
The DynaTone Phono-Radio-Electronic Piano.....	Arthur C. Ansley	398
A Television Kit.....		399
Make This Plug-Together 8-Tube A.C. Receiver.....	Lewis L. Sharrard	400
The Proposed Television Standards—Are They Fair to All?(With comments by Wm. H. Priess)		402
Complete Step-By-Step Dynamic Servicing—Part I....	Kendall Clough	404
"Farmer's Friend"—A 6-Tube Super. Using New I.4-V. Tubes	Glenn H. Browning & F. J. Gaffney	406
Making a Serviceman's Test Unit—The "Super-Geno-Scope"—Part II	Canio Maggio	408
New Circuits in Modern Radio Receivers—No. 16....	F. L. Sprayberry	410
The Skin-Effect Talking Lightbeam.....	Gerald Mosteller	411
All About Ballast and Resistor "Tubes".....		412
The Latest Radio Equipment.....		414
Servicing Questions & Answers.....		415
Operating Notes		416
Radio Trade Digest.....		417
RADIO SERVICE DATA SHEETS:		
No. 244—Silvertone Models 6110 and 6111; Zenith Models 6D302, 311, 326, 336, 360 (Chassis Model 5646)		422
No. 243—Knight Model EI0913; General Electric Model GD-52		423

In the NEXT ISSUE

Broadcasting as I Imagined
it—by Dr. Lee de Forest

Equipment and Procedure
for Servicing "Intermit-
tents"—by Harl O. Piety

Unique Sound Effects

"The Lunchbox 5" — An
Easily-Built Portable—by
G. E. Archenbronn

★ OUR COVER . . .



... from an original photo taken by
the Terry-Holden expedition into the
Brazilian jungle.

★
Published by Radcraft Publications, Inc.
Publication office: 29 Worthington Street,
Springfield, Mass. Editorial and Advertising
Offices: 99 Hudson Street, New York City.
Chicago Advertising Office: RADIO-
CRAFT, 520 North Michigan Avenue, Chi-
cago, Ill.

RADIO-CRAFT is published monthly, on
the first of the month preceding that of
date; subscription price is \$2.50 per year
in U. S. and Canada. (In foreign countries,
\$3.00 a year to cover additional postage.)
Entered at the post office at Springfield as
second-class matter under the act of
March 3, 1879.

Foreign Agents:

London—Gorrings's American News Agency,
9A Green St., Leicester Square, W. C. 2, Eng-
land.

Paris—Messageries Dawson, 4 Rue Faubourg,
Poissonniere, France.

Melbourne—McGill's Agency, 179 Elizabeth
St., Australia.

Dunedin—James Johnston, Ltd., New Zealand.

★
Text and illustrations of this magazine are
copyright and must not be reproduced
without permission of the copyright owners.

★
Copyright 1938 Radcraft Publications, Inc.

TRAIN FOR RADIO IN 12 WEEKS

BY MY QUICK, EASY "LEARN BY DOING" METHOD



Prepare today to enter a real money-making field by my quick, easy way to learn Radio. Here in my school you are trained in 12 weeks for your start for a better job and a real future. You do actual work on a great outlay of Radio equipment. The remarkable "Learn-By-Doing" methods used in the great Coyne Shops train you in **Radio, Television** and sound equipment servicing. Not by books . . . Not by Correspondence . . . But all under the individual guidance of skilled instructors, and only on similar kind of work you will meet out on a real job. My methods make it **easy to learn**—First you are told how to do a thing—then you are shown how to do it—then you **do the work yourself**. WHERE ELSE CAN YOU FIND SO QUICK AND EASY A WAY TO GET PRACTICAL TRAINING IN THIS GIANT INDUSTRY?

I'LL FINANCE YOUR TRAINING

DON'T LET LACK OF MONEY keep you from sending in the Coupon TODAY. Learn how you can get training first and take more than a year to pay for it after graduation. Make your first payment 60 days after your regular 12 weeks' training period ends. Then take over a year to pay the balance of your tuition in easy monthly payments. Hundreds of ambitious fellows have used this method to get Coyne Training. **FILL IN THE COUPON AND MAIL IT TODAY.** It will bring you the details of this amazingly quick and easy way to get your start towards a good pay job.



H. C. Lewis

Radio—Television—Sound Equipment

Your training at Coyne is in wonderful, modern daylight shops on the finest kind of **RADIO, TELEVISION** and **SOUND EQUIPMENT**. Television is sure to come as a commercial industry, whether this year or next. Talking Picture and Public Address Systems offer opportunities for the trained man. Everything possible has been done to make your stay at Coyne happy and healthful as well as profitable.

Electric Refrigeration Training Included at No Extra Cost

This combination Training (Radio and Refrigeration) can be of great value to you. Whether you go into business for yourself or get a job working for a Radio Sales and Service organization, the fact that you are trained in servicing Electric Refrigerators should be profitable to you. Many Radio Manufacturers also make Electric Refrigerators and men with this combination training are much more valuable to these employers. You can **NOW** get this training without extra cost.

No Advanced Education or Previous Experience Needed

If you can read and write simple English and are ambitious you can be trained the Coyne way—by actual experience on a wide variety of up-to-date Superheterodyne sets, oscillators, analyzers, and test instruments. You learn how to operate television receiving and transmitting equipment and how to install, test and service public address systems and sound picture equipment. Coyne training also helps prepare you to qualify for a job as operator in Broadcast, Ship, Police or Aircraft Radio stations. Also for amateur operators license. Send coupon for all details.

Part Time Work While Learning Employment Service after Graduation

If you need part time work to help pay living expenses while training, my Employment Department will help you get it. They will also give you Lifetime Employment Service after you graduate.

Mail Coupon Today I'll Send You All the Facts

Get the new "Coyne Opportunity Catalog," giving all facts about Coyne Training. Photographs of Shops showing students at work on modern radio equipment under the personal supervision of Coyne Expert Instructors. Also details of my Part Time Employment Offer, Pay After Graduation Plan and Graduate Employment Service. Yours without cost. Simply Mail the Coupon.



H. C. LEWIS, President RADIO DIVISION **Founded 1899**
COYNE ELECTRICAL SCHOOL
500 S. Paulina St., Dept. 19-8H Chicago, Ill.

H. C. LEWIS, President,
Radio Division, Coyne Electrical School,
500 S. Paulina St., Dept. 19-8H, Chicago, Ill.
 Send me your big **FREE** Book about Coyne Training and give me all details regarding your "Part Time Employment Offer" and "Pay After Graduation Plan" of easy, monthly payments.

NAME.....AGE.....
 ADDRESS.....
 CITY.....STATE.....

Please Say That You Saw It in RADIO-CRAFT

HOWARD

Sensation

OF THE YEAR IN
**COMMUNICATION
RECEIVERS!**

gives you
DX ON 10 METERS
with
ELECTRIC BAND SPREAD



\$29.95
NET

**MODEL 430
SIX TUBES
4 BANDS**

**Yes Sir! The Hottest
Most Popular
Communication Set
ever introduced —
the value of values!**

ORDER YOURS NOW

A hand-built Howard with the custom parts, fine engineering and spectacular performance features of communication receivers selling for twice the price or more. Has four bands—broadcast to 10 meters inclusive. Ceramic coil forms, Iron Core I.F. Transformers, Electrical Band Spread, Excellent 10 Meter performance and eleven additional communication features.

Free For Complete Technical Details see Your Jobber or Send This Coupon

HOWARD RADIO COMPANY
1735 W. Belmont Avenue
CHICAGO, ILLINOIS

Gentlemen

Please send me Booklet No. 450.

Name _____

Address _____

City _____

State _____

RC-139

**The IDEAL SET
for the DX FAN**
A Sensation with Advanced Amateurs
at the National A. R. R. L. Convention

Receiver has speaker installed and comes complete with radio tubes and other accessories—nothing else to buy

Outstanding Advanced Models



MODEL 440

9 Tubes—5 Bands—Frequency Coverage .54 to 40 MC (7.5 to 555 meters)
Ceramic Coil Forms . . . Electric Bandspread . . . Iron Core I.F. Transformer . . . B.F.O. with pitch control . . . S.L.F. Ceramic Insulated Tuning Condensers . . . R.F. on all bands . . . Calibrated "R" Meter . . . Crystal filter . . . Price, with tubes, less speaker, less crystal . . . \$66.50 Net

PRICES SLIGHTLY HIGHER WEST OF ROCKIES AND EXPORT

MODEL 450-A

12 Tubes—6 Bands—Frequency Coverage .54 to 65 MC . . . Ceramic Coil Forms . . . Dual I.F. Channels . . . Two S.L.F. Ceramic Insulated Tuning Condensers . . . 47 inches of electric bandspread . . . crystal filter . . . Calibrated "R" Meter . . . Accurately calibrated direct reading dial . . . Price, with tubes, less speaker, less crystal . . . \$87.50 Net



America's Oldest Radio Manufacturer

Please Say That You Saw It in RADIO-CRAFT



' ' T A K E S T H E R E S I S T A N C E O U T O F R A D I O ' '

THE TELEVISION RACKET

By the Editor — HUGO GERNSBACK

It is an unfortunate fact that the Radio Industry, ever since its inception, has been handicapped by unscrupulous promoters constantly using the industry as a spring-board for their own enrichment.

This condition dates back to 1903 when Radio still was in its swaddling clothes and still called Wireless. Even in those early days we had the glib-tongued, crooked promoter who sold worthless stock and securities sugar-coated with the most fantastic get-rich-quick schemes. Unfortunately, in those days anything connected with Wireless was magic and the public fell for it in large numbers. It made no difference how hare-brained the scheme may have been, for there were always takers who usually woke up to find, too late, how thoroughly they had been swindled.

Television, the newest branch of Radio, is no exception to the unfortunate rule that evidently new suckers are born every minute of the day.

A few years ago, about 1932, when Television made an ill-advised bid for public acceptance it was these promoters in many parts of the country who were not slow to seize their opportunity. A number of unscrupulous stock promoters had a scheme that was simplicity itself. At that time I was publishing the magazine *Television News* and there was not a day that went by but what some promoter called up, wanting to get the name of this or that television "inventor." If they could not get an inventor they wanted to get some one to give them an idea on television—any idea, no matter what it was so long as it had to do with television. Of course, we didn't supply any names but they had no trouble in getting hundreds of men and boys with half-baked ideas and immediately set forth to put out their stock issues. There never was any thought of manufacturing anything. Nine out of 10 times there was nothing but a sketch or a blueprint, without even a model. Nevertheless such a crude basis was quite adequate for selling worthless securities. Sad to relate, not one of these companies lasted even 6 months; none of them is in business today.

A recent announcement by the Radio Corporation of America—the largest radio concern in the United States—that next Spring they will begin to manufacture and sell television equipment is, of course, one that must be listened to with respect. No organization of the responsibility of the Radio Corporation of America would make such an announcement unless they were sure of their ground. The industry as a whole has been much gratified by this announcement because it now feels that the time has come when television will actually come out of the laboratory and into the public's homes.

Unfortunately, also, this announcement will, as usual, be welcomed by dozens of irresponsible promoters who will immediately lay plans to cash-in on the new and coming Television Industry.

While, since 1932, there has been a good deal of television promotion here and there—the latest and the most ambitious one blowing up only 2 months ago—there has not been a superabundance of these schemers.

However with an authoritative statement on record that television will take actual shape next Spring we know from

past experience that there will be foisted on the public dozens and soon hundreds, of worthless television promotion schemes, all of which will bid for the investors' dollars. Promoters will try with their usual wiles to lure every last dollar from the hard-earned savings of the gullible.

This is an unfortunate condition and even with the restrictions which are now being placed on new stock issues, it is certain that most of the promoters will succeed because they only have to be a little more careful and a little more plausible with the authorities. In the end the public will be fleeced as usual and television no doubt will get the same black eye that radio got in the heyday of the radio boom from 1921 to 1927.

Now of course not all television stock may be worthless, but certainly over 90% offered in the next few years will be in this class.

To those who are asked to invest in television stock or securities there are a few very simple rules which, if followed, will make it reasonably certain that the would-be investor will not be victimized. These rules are as given below.

Do not commit yourself on any investment on television stock unless you have taken into full consideration all of the following points:

- A—It is safe to say that no television corporation, unless it has been in business for at least five (5) years, can be trusted. Beware particularly of all new television companies unless they should be a merger of two or more older firms, more than five (5) years old.
- B—Get the opinion of at least three (3) radio editors of national radio magazines or trade papers, *in writing*.
- C—Write a letter to the President of the Radio Manufacturer's Association at 1317 F Street, N. W., Washington, D. C., and ask his opinion as to the worth of the company whose stock you are asked to buy.
- D—Ask the advice of your local bank as to the stock in question.
- E—Get a report from Dun & Bradstreet, Inc., on the corporation and its personnel. This is particularly important because no corporation is any better than its personnel.

After you have obtained *all* of this information, not having neglected any single point, then you are in position to act. You will find that few companies or corporations will come out with flying colors after such an investigation by yourself and only the oldest and reputable ones, who have been at it for many years, will get your entire confidence.

And it is also a most significant fact that it is these very companies which do not, as a rule, try to sell you any stock at all; as compared to the usual high-pressure methods known to only the fly-by-night promoters.

Remember also that television is now in its inception and for that reason more than any other, any television stock which you might buy, for many years must be in the nature of a speculation.

THE RADIO MONTH



SCHOOL TELEVISION!

A new desk-type instrument provides for every sound requirement of the modern educational institution of from 20 to 120 rooms, including radio and recorded programs for any or all rooms, 2-way communication with classrooms, and speech input. Note the following quote from RCA Victor's release, last month, describing this apparatus: "Both radio receivers include an ultra-high-frequency band which will permit the installation of an attachment for radio television reception, when such programs become available for use in schools." RCA Sound Engineer Paul Weathers is explaining things to Ellsworth C. Dent, Educational Director of the company.

TELEVISION

THE British Broadcasting Corp. (B.B.C. to you and you) last month sprang a clever bit of television publicity American interests may be interested to note. In a series of free programs entitled, "Television in Action," the activities on the television wavelengths being viewed by the privileged few who own video receivers is put on the air for the edification of listeners who are tuned in to the regular broadcast wavelengths. This hybrid program therefore serves a dual role of filling out time with what may be presumably but an acceptable sound program and at the

same time whetting listener interest in the television activities in the ultra-shortwave band. This series of 3 programs is not being broadcast from prepared scripts. The first program will consist of the actual sound part of a weekly television feature entitled "Picture Page" exactly as it is broadcast from the television station, and a commentary on what is happening in the television studios at the time will be given by John Snagge. The second of these programs, which will be heard about a fortnight later, will consist of an actual "local O.B. (outside broadcast)" of a balloon barrage demonstration in the grounds of Alexandra Palace, and again John Snagge will describe what is happening. The third program will be an account of the televising of the Cenotaph Service on Armistice Day.

The Don Lee Broadcasting System last month announced the sale of "certain patents" to the Radio Corporation of America. In reply to telephone inquiry by *Radio-Craft* RCA stated that these patents are broad and basic in the field because of the early date. The patents cover inventions by Harry R. Lubcke, director of television for the network (articles by him have appeared in past issues of *Radio-Craft*), and includes rights in the United States, Canada, Germany and Great Britain. Included in the group of patents is one on synchronization, making possible operation of the receiver independent of any wire line or other connection to the transmitter. Readers will recall that television pick-up in an airplane of images being sent by a ground transmitter was accomplished in 1932 by Mr. Lubcke.

According to the *Little Chronicle*

(Oak Park, Chicago) last month, medics have found that television is helpful to the nervous system. A patient in an English hospital, to quote the magazine, "quite by chance . . . was left alone with a television set in action." As a result her nervous system was so calmed that pains had subsided to such an extent as to make it possible to postpone the proposed operation and permit nature to effect a cure.

Add Allen B. Du Mont Labs., Inc., Passaic, N. J., to the list (see *Radio-Craft*, pg. 80, August 1938) of those Co.'s OK'd last month by the F.C.C. for television channels. Rating 50 W., frequency range 42 to 56 megacycles—at this time. Purpose of the transmitter: "to test and demonstrate the Du Mont television system and also for various tests in connection with improved circuits and methods."

The largest television receiving tube yet made available to American workers & television enthusiasts provides a full 10-in. image with all the brilliancy, sharpness and flickerless characteristics of home movies, when properly operated. According to information received last month from Allen B. Du Mont Labs. in connection with their huge 14-in. C.-R. tubes, production machinery is capable of turning out "dozens of such tubes each working day." The cost of these tubes is about \$75.00 each.

PUBLIC ADDRESS

KNOCKED unconscious by contact with a 2,000-V. circuit, Fred Lyle, radio man in Cleveland's Public Auditorium,



A WORKER IN AN AMERICAN FACTORY CHECKS-UP A . . . "14-INCH" TELEVISION RECEIVER AND ITS HUGE C.-R. TUBE

Here you see illustrated the "Big Bertha" television receiver announced last month by Allen B. Du Mont Labs. It uses the largest-size television receiving tube made in the United States. This tube, also a Du Mont product, has a black/white screen; image area is about 8 x 10 inches. As many as 50 persons for display purposes. Sells for just under \$400.

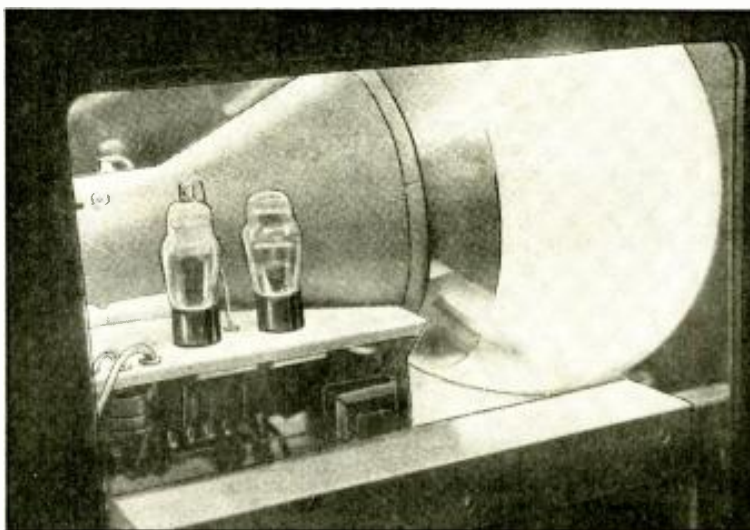

can simultaneously view this tube's large screen. Note that this receiver operates satisfactorily on either single-sideband or double-sideband modulation. Controls have been reduced to 6. Set has 21 tubes, including C.-R. tube. Cabinet is 25 x 15 1/5 x 25 ins. deep, and glass-sided; interior is neon-lighted for display purposes. Sells for just under \$400.

IN REVIEW

last month utilized the auditorium's P.A. system to ask for aid when he "came to."

Most theatre attendees are subconsciously aware that stage performers are seldom heard except via the P.A. system. Now, the use of tiny microphones concealed in clothing, hair and hats, eliminates need for the mike stand, it was reported last month. The trailing lead however is still a problem.

AMATEUR RADIO

ACCORDING to the *New York Times* of last month, radio amateurs cooperating with scientists at Harvard University have shown that the electrified "E" layer about 75 miles above the earth apparently contributes to bending of ultra-short-waves. Result: reception up to 2,500 miles distant of signals in the 56-60 megacycle region (close to the present television bands).

Said the A.R.R.L. to the press last month, in effect: Don't ask the radio amateur to do your reporting for you in the instance of communication into or out of hurricane, flood or other areas of disaster. "The radio amateur is not a reporter. He is a communicating agency; he will take your dispatches and transmit them to their destination as quickly and accurately as his facilities will permit."

Radio amateurs succeeded in locating explorer Henry Walter last month on the southern edge of the Aleutian Peninsula to inform him that his mother was dying. The first leg of a 5,000-mile race against the Grim Reaper started in Alaskan waters. It is estimated a month will be needed to complete the trip.

SHORT WAVES

ACCORDING to information received from International Telephone and Telegraph Corp., the Italian Broadcasting Company put into service last month at Prato Smeraldo, near Rome, a 100-kw. shortwave broadcaster which is "the highest-powered shortwave broadcaster which has yet been installed, and the first which will give world-wide radio service."

Here is the oddity: "The wavelengths need to be changed (Continued on page 425)"



MOVING DAY

Pioneer broadcast station KDKA plans to move from Saxonburg, Pa., to a point about 10 miles from the center of Pittsburgh, it was reported last month. Reason given is that it may be several years before permission is obtained to use the full 50 kw. which the Saxonburg set-up was rebuilt to use, last year. The 15-ft.-long blimp shown above is gas-filled, and is trailing a 1,000-ft. antenna in an aerial survey to find a good spot to which the 718-ft. Saxonburg antenna mast can be moved.



DEDICATION

Last month Maxim Memorial Radio Station WIAW was officially dedicated by Dr. E. C. Woodruff, President of the American Radio Relay League, at a ceremony before a gathering of 100. At the ceremony, Dr. Woodruff unveiled a memorial tablet in the lobby of the station. (See photo above.) (Should we say "a" founder?—Hugo Gernsback's "Wireless Association of America" is believed to have ante-dated the A.R.R.L.—*Editor*)

Among those who paid tribute to the "founder of organized amateur radio" were his son and daughter, Hiram Hamilton Maxim and Mrs. John G. Lee; officials of the League; Brigadier General William F. Ladd, who represented Governor Cross; and, local city and town officials.

The \$18,000 memorial station is one of the most complete amateur radio stations in the world. The performance of 5 separate and powerful transmitters is enhanced by special antenna systems designed for most efficient coverage of North America. Purpose of the station is to maintain efficient contact with members of the League throughout the country.



Dedication ceremonies at the A.R.R.L. Memorial Station at Newington, Conn.



Memorial Station WIAW is located near the Headquarters at West Hartford.

THE TERRY-HOLDEN JUNGLE EXPEDITION

A unique expedition which carried portable short-wave receiving and transmitting equipment deep into the wilds of the Amazonian jungles of southernmost British Guiana left much of its thrilling stories untold in those broadcasts back to civilization.



↑ Above is shown Dr. Wm. Hall Holden and a native Wai Wai Indian broadcasting over N.B.C. station VP3THE. While sweltering in the heat at the base of the Akari Mountains Dr. Holden and his party held a conversation with the Clifford McGregor group less than 600 miles from the North Pole.

← At left, Orison W. Hungerford, radio operator of the Holden expedition, points out the jungle journey that 2-way radio made possible.



Above is illustrated N.B.C. portable station VP3THE at the expedition's base in the Sierra Akari range in British Guiana (S.A.).

BACK in N.Y.C. after an expedition that took him deep into the jungle of British Guiana, on the first crossing of the Akari Mountains and finally down the broad Amazon in Brazil, Dr. William Hall Holden recently dropped into Radio City to tell of his experiences in the jungle. The Terry-Expedition heard, during its activity in the jungle, in a series of programs over the National Broadcasting Company.

COVER FEATURE

"We found radio an invaluable aid in our expedition work," said Dr. Holden, staff surgeon of the American Museum of Natural History. "It kept us in constant touch with our base camp at Ishertun. It enabled us to get supplies from Georgetown, the starting point of our expedition. And I can never thank N.B.C. enough for bringing me and my 3 companions the voices of our nearest relatives last Christmas Eve when we were thousands of miles from home and sweltering in the heat at the base of the Akari Mountains."

That Christmas broadcast that came from a practically uninhabited botanical garden was unique. Dr. Holden and his party, camped near the Equator, not only talked over the nationwide networks of N.B.C. They also exchanged greetings with their relatives gathered at Radio City and traded compliments of the season with another expedition, the Clifford MacGregor group, quartered less than 600 miles from the North Pole.

Broadcasting, of course, was not the prime purpose of the expedition. The party set out to collect specimens for the New York Botanical Gardens, investigate the diseases and medicinal properties of native herbs, and generally to explore a hitherto uncharted country. And it led to some astonishing, and dangerous experiences.

For a month Dr. Holden and a companion, in crossing the Akari Mountains, lived on a diet of rice and flour. That ended only when the party encountered a Brazilian border commission on one of the tributaries of the mighty Amazon. During the 6 months Dr. Holden was in the "bush" he made more than a thousand extractions of teeth from suffering Indians. It created an immense amount of good-will, he said, because the native way of getting rid of an infected tooth is to explode it by contact with a red-hot nail. (The hot nail heats the inherent tooth mois-

(Continued on page 424)

MARCONI— FATHER OF RADIO?

As expert witness for the United States in many important court cases involving pre-World War and World War use of patented inventions Commander Loftin had access to perhaps the most complete existing references concerning the pre-Marconi and Marconi days of radio. The following article (exclusive to RADIO-CRAFT) embracing hitherto unpublished facts contained in this reference material hence becomes an exceptionally important contribution to radio literature.

LIEUT.-COMMANDER EDWARD H. LOFTIN,
U.S.N. RESIGNED, M. I.

ABOUT 60 years before I took up residence on earth, in the backwoods of Alabama, Michael Faraday, an Englishman, became muchly inquisitive about there being possibility of relation between light and electricity, and many other effects nature had priorly made known to humanity more or less step-by-step.

Faraday—Maxwell—Loomis. While so engaged, Faraday became acquainted with James Clerk Maxwell, a Scottish antecedent of myself, both being members of the faculty of Cambridge University, and disclosed to him his visions including relation between light and electricity, all of which received warm and sympathetic response on the part of Maxwell; and so much so, that following Faraday's passing away Maxwell qualified as an inheritor of Faraday's visions. To perpetuate the one bearing on relation of light to electricity Maxwell mathematically expressed his and Faraday's visions as the "electromagnetic theory of light" which, analyzed, put light and electricity in the same family. Maxwell, being certain about the logic of his mathematical treatment of the relation of light and electricity, did not bother to prove it by experimentation before he passed away.

Faraday did prove that a body, or electrical conductor, energized electrically sends forth in surrounding space *lines of force*, visioned to extend to infinity, and that use could be made of these lines of force in space, he having put this knowledge into invention of the now muchly-used electric generator which offers no promise of becoming obsolete.

With the idea of electricity not staying put in bodies and/or conductors, but wandering around as willing-to-work lines of force, being promulgated, Dr. Mahlon Loomis, an American residing in Washington, D. C., was granted United States patent on July 30, 1872, disclosing as one form of practical use of these electrical effects the sending of messages between locations having provisions for creating electrical disturbances, and each of them being able to detect the disturbances set up by the other. This was followed by Smith, a good American name, proposing sending signals from a wire paralleling the tracks of a railroad through space to cars moving therealong.

Phelps—Dolbear—Edison—Hertz. Americans Phelps, Dolbear and Edison obtained United States patents in 1885, 1886 and 1891 respectively for ideas along the line of Loomis, and the British interests that undertook to financially back Marconi, Italian, spent many years and much money

Copyright to this article is limited to the author's name.



EDWARD H. LOFTIN

in effort to belittle these proposals of Americans because they did not specify use of very-high-frequency alternating electrical current with which to create signal-representing disturbances proposed by Loomis. This even though Maxwell's "electromagnetic theory of light" holds good for all frequencies.

Heinrich Hertz, a stubborn German not willing to believe without proof, set to work in the 1880's to experimentally prove or disprove Maxwell's mathematical treatment of Faraday's "electromagnetic theory of light"; and by 1886, with his now muchly famous oscillator, proved that Faraday's visioned lines of force do move outward from their sources with the velocity of light, and could be detected in space, these experiments having been conducted with very-high-frequency alternating current.

Pupin—Lodge—Crookes—Helmholtz. Even though this experimental confirmation by Hertz of Faraday's vision about the relation of light and electricity set the scientific element of the world on fire when made known, including such personalities as Professor Michael Pupin, my post-graduate instructor at Columbia University, Sir Oliver Lodge of England, and Sir William Crookes of England as being the answer to electrical communications to great distances through space, the Marconi interests have fought this bitterly with prolonged attempts to belittle this accomplishment on the part of Hertz because of it having been in a laboratory within limited distance; but the truth

is that had Hertz not soon passed away his initiative and genius would have led him to prove to the world that Faraday was correct in visioning that the lines of force of electricity extend to infinity, Hertz having inherited from Maxwell and Faraday, at the instigation of Hermann von Helmholtz, Professor of Physics of Berlin University at the time, the inspiration to confirm their visions in full experimentally. Hertz unfortunately died in 1894.

Professor Pupin, being a student at the University of Berlin under von Helmholtz, was among the first competent scientists to learn the results of Hertz's experiments, von Helmholtz having read Hertz's preliminary report to him in a meeting of the Physical Society at the end of 1887, which meeting Professor Pupin had the honor of attending. This led to Pupin, soon after taking up professorship at Columbia University, developing "electrical tuning" daily used in most of the homes of the world today.

Sir William Crookes, in writing in the *Fortnightly Review* of 1892, prophesied that the work of Hertz with ether waves would provide transmission of Morse code signals by having the sending and receiving apparatus tuned to a special wavelength already provided by Professor Pupin.

Hughes—Branly—Popoff. At this point the only feature needed to make the apparatus practical and commercially acceptable was a means of detection of signal-bearing electrical energy in a way to permit of interpreting the signals with human senses, and this was contributed in 1892 by Edouard Branly, a Frenchman using an idea obtained from David Edward Hughes, an Englishman, that resulted in the now obsolete famous "coherer". This device did not reach practical form until Popoff, a Russian scientist, conceived the idea of adding to Branly's coherer a vibrating device to cause decohering from signal to signal, namely, a tapper that would operate immediately coherer action was obtained by reason of an incoming signal. The successful use of this device was disclosed by Popoff in the *Journal Physico Chemical Society*, St. Petersburg, in 1896.

Marconi. Now I clear the stage for Guglielmo Marconi, an Italian. In 1895 he erected a typical Hertz oscillator on his father's estate at Bologna, Italy, and with a Branly-Popoff coherer detector successfully transmitted electrical communications signals within the limits of said estate just as Hertz was limited in his laboratory, even though Faraday had made infinity a limit. With this result accomplished, Marconi audaciously filed an application for patent in England in 1896 in his own name dis-

(Continued on page 426)

NEW RADIO ALTIMETER

Last month radio helped immeasurably to promote aviation safety. A great laboratory, a great air planes, that accurately indicates height above

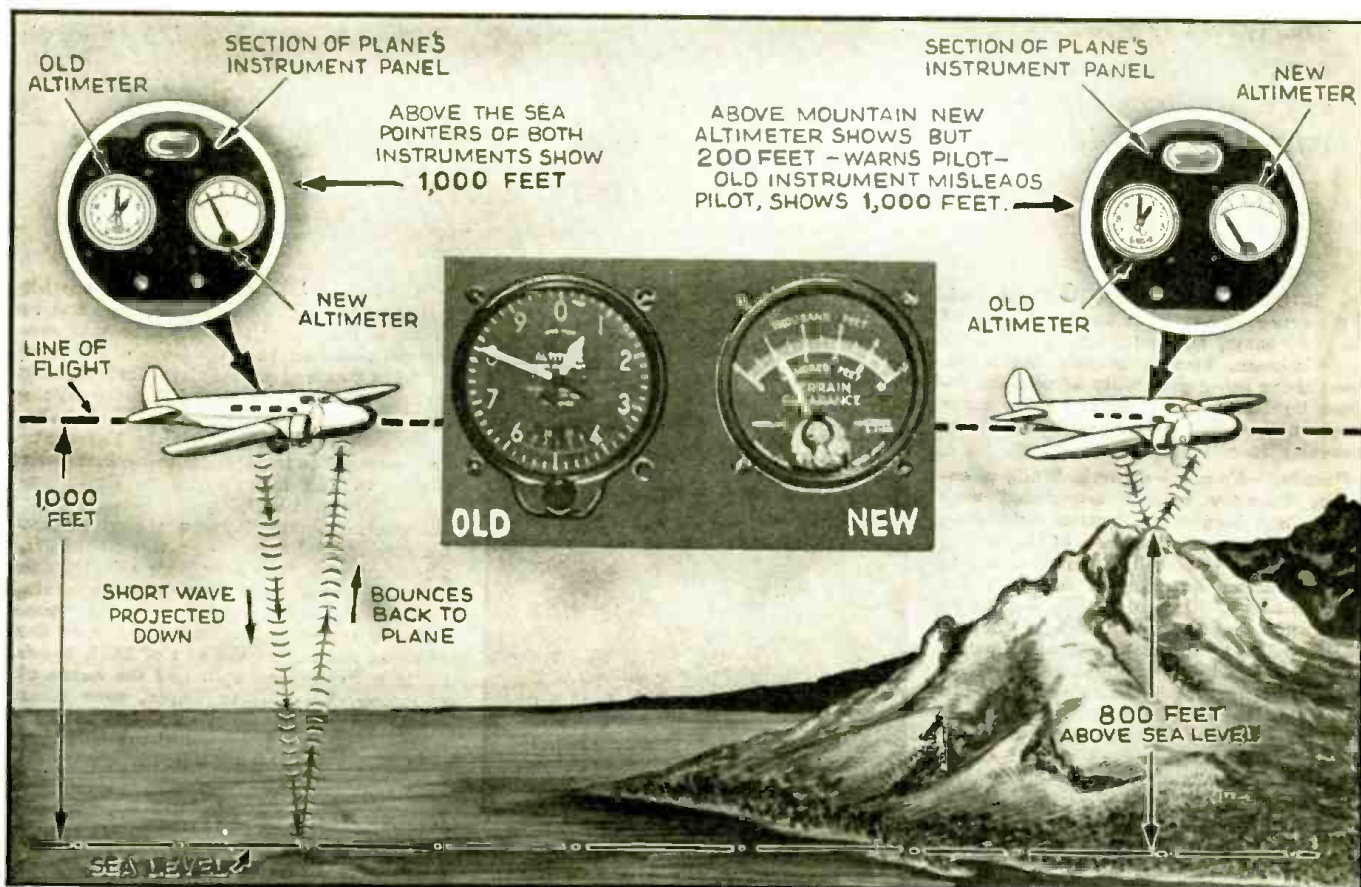

News flash: "Wreckage of plane found on side of mountain by searching party. All aboard apparently instantly killed."

HOW many times have you read some such tragic report as the above, in connection with an airplane crack-up on a mountain? Published figures place this general type of plane casualties at about 50 per cent; imagine it — one-half of all plane crashes in which, due mainly to poor visibility (fog, etc.), the "ship" smacked head-on into obstructions of which the pilot was unaware. Too frequently its passengers and crew have passed into Eternity.

ACHILLES' HEEL

How could such a catastrophe occur? The motor was working perfectly; the pilot was experienced and trustworthy; the radio equipment and flying instruments were in perfect working order—except that the altimeter locked in position by the impact indicated a height of several thousand feet!

Ah!—THERE IS THE ANSWER.

Several thousand feet — above SEA LEVEL . . . but the plane was

R. D. WASHBURNE

flying in mountainous country and the altimeter did not, could not, indicate height above LAND.

The aeronautic-type altitude indicator operates on the principle of the aneroid barometer. This type of instrument indicates height (altitude) with respect to a reference level having constant barometric pressure—a condition which is found only at sea level.

Engineers have worked unceasingly to develop an altimeter that would indicate height above land with the same or greater accuracy now possible over water (or land at water-level).

DEMONSTRATION

Last month radio as shown in the heading illustration solved the problem. The radio-operated "Terrain Clearance Indicator" proved its ability in direct comparisons with the Standard Altimeter; the panel meters of both systems were mounted side-by-side as shown in Fig. A (insert, in heading illustration).

Bell Telephone Laboratories developed this microwave radio altimeter,

Western Electric Co. made the equipment, and United Air Lines installed the apparatus in a special Boeing twin-engine airliner. In cooperation, these 3 groups demonstrated the efficiency of the new radio altimeter in a test flight over New York.

Despite weather conditions or poor visibility, the pilot could read his height directly and accurately whether he was several thousand feet high or merely skimming a few feet above the earth.

So keen is the sensitivity of the new altimeter that, from an altitude of several hundred feet, the presence of the George Washington Bridge was clearly indicated by the meter as the test ship flew down the Hudson River, far above the actual obstruction itself. Over the Hudson River both altimeters indicated a height of about 800 ft.; when the plane swung over the Palisades, the standard altimeter continued to show a height of 800 ft. but the Radio Altimeter indicated the fact that the ground was only 250 ft. below the plane!

(No comment has been forthcoming as yet concerning provisions for indicating conditions dead-ahead—an abruptly-rising plateau, for instance—

INCREASES AIR SAFETY

industrial plant, and a great airline combined to develop, build and test an altimeter, for use on land-level (including buildings and bridges).

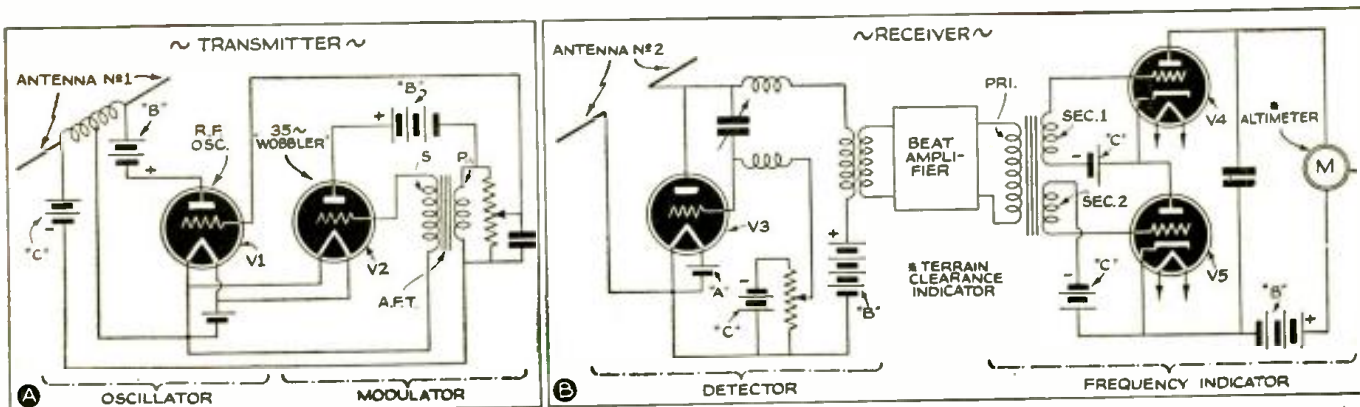

Fig. 3. These theoretical, composite diagrams illustrate the sequence of operations. The frequency-modulated signal results in a beat frequency that may be resolved on an output meter into terrain clearance indications in feet.

but undoubtedly means will be found to take care of this condition.—*Author*)

Extended flight tests of the new development are being made over regular airways by engineers of Bell Telephone Laboratories in a special Boeing twin-engined airliner assigned by United for service testing.

The principle of operation, shown in a general way in Fig. 1, is as follows:

A frequency-modulated, 500-mega-cycle (0.6 meter) signal—highest frequency ever to be used for practical purposes, it is said—from a transmitter (A) is radiated from antenna No. 1 (B) as signal C to ground (D). The reflected signal (E) is picked up by antenna No. 2 (F) connected to a receiver (G).

Although antenna No. 1 is directive toward the ground a considerable amount of energy "slops over" to antenna No. 2 (note direction of arrow, H).

This "slop-over" signal combines with the reflected signal and, in receiver G, produces a beat frequency which is segregated by an "interference measuring device" (I) and indicated on a unit, on the instrument-panel in front of the pilot, called a "terrain clearance indicator" (J).

The beat frequency is a function of the height, and directly proportional to it. Therefore the radio altimeter (J) is calibrated for direct-reading in feet. In order to understand how this radio altimeter functions it may be well to mention some of the principles previously employed.

PRIOR ART

(1) The idea of measuring the capacity between airplane and ground is not considered practicable due to the fact that capacity variation is large for low altitudes but very small for high altitudes. (2) The principle of measuring the phase difference between a radiated wave and its reflection is difficult to realize in practice. (3) The

scheme of sending an impulse and then determining the distance as a function of the elapsed time before the reflection (echo) is received although useful in measurement of ionosphere heights is not applicable for short distances because of the minute time element involved. (4) The frequency-modulator radio wave principle—and the one upon which the new system is based—affords a continuous and linearly proportional indication of altitude.

Merely to mix, at the receiver, original and reflected signals of the same frequency (since there would be no change in frequency due to reflection from the ground) would not produce a beat.

AUDIO EXAMPLE

This is easy to understand if we take the example of a person whistling a single note uninterruptedly. Unless the continuous whistle is interrupted for a certain length of time it is not possible to hear an echo (reflection) should one exist. Interrupting the whistle and noting the lapse of time until the echo is heard may be taken to represent the impulse method of determining distances.

Let us suppose that instead of a continuous single note, a continuous sequence of notes is whistled. To make the point more clear let us suppose that the note is warbled up and down the scale, considering however, that in warbling only 2 notes are sent out.

First we whistle note No. 1; then, 2nd, note No. 2; 3rd, No. 1 again; 4th, No. 2 again, and so-on. Now, if we are far enough from a reflecting surface so that note No. 1 reaches our ear as an echo just as note No. 2 is being whistled we will be able to hear not only both notes simultaneously but also a 3rd or beat frequency due to the heterodyning (mixing together) of notes 1 and 2. Without going into too much additional detail let us take for granted that a meter arranged to show

the presence of these beats could be calibrated to indicate the number of feet that note No. 1 had to travel before it heterodyned with note No. 2; for maximum indication on the "beat" meter this will always be a fixed distance.

How then can we obtain beats whose readings on the beat-meter will be equivalent to other distances?

FREQUENCY MODULATION

Well, let us consider a second example in which we wobble the frequency 5 notes up and down the scale instead of warbling only 2 notes. The note sequence would then look like this: No. 1-2-3-4-5-4-3-2-1-2-3-4-5-4-3-2-1-, etc.

Now, if, at the time note No. 4, let us say, is being sent out, note No. 1 is received, it indicates that the sound had to travel so far to produce an echo that a 4-note lag resulted; and since each additional note lag means the

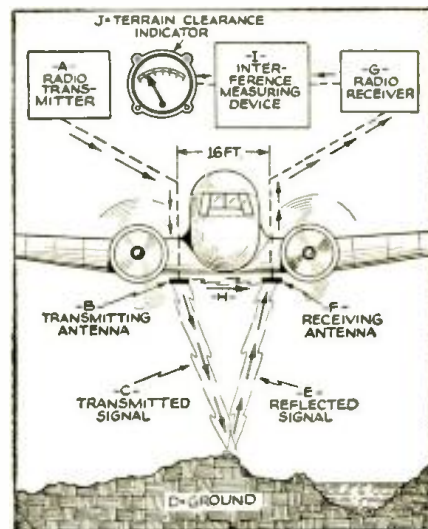

Fig. 1. Signal C and reflection E are shown beamed, only for purposes of illustration. Actually they are only semi-directional. Antennas B and F are each 1 ft. long. This radio altimeter is effective from heights of 100 to over 10,000 ft.



This Home
WIRED FOR RADIO
 SPONSORED BY
Radio-Craft
 MAGAZINE
 RADIO EQUIPMENT
 RCA-VICTOR - MASTER RADIO AND SPEAKERS
 MALLORY-YAXLEY REMOTE SWITCHES, OUTLETS
 BIRNBACH SPECIAL WIRING EQUIPMENT
Assisted by WALTER MEZICKS Chief Staff Writer

PART I

FOR THE
FIRST TIME
 IN ANY
RADIO PUBLICATION

N. H. LESSEM

Teaneck, New Jersey, is a pretty town. And like thousands of other residential communities in the United States boasts of well-planned home developments. But something happened in Teaneck last month that may have far-reaching influence on the radio and building industries; and particularly upon the future owners of more than 100,000 new homes which it is estimated will be built during 1939.

RADIO-CRAFT has developed what is said to be the most outstanding radio merchandising idea in years. To make the acid test, a 5-room bungalow-type house in the \$7,500 class is being built in Teaneck.

That this is no ordinary home will be disclosed in a series of articles (of which this is the first); instead, we believe it is the forerunner of many more such homes which, like this one, will be—

WIRED FOR RADIO!

THE radio industry occasionally becomes anemic and requires a blood transfusion to give it new life. In the past, these transfusions have been in the form of new equipment developments—new circuits, new “gadgets,” new cabinets—which really improved the receivers over those of the preceding years. These new features kept the public mind (and purse) trained on radio.

Of late however, these developments have been of an increasingly technical nature;—so technical, in fact, that it frequently requires all the oratory a silver-tongued salesman can muster to “sell” a prospective customer on the idea of purchasing a modern radio set—merely on the strength of the salesman’s say-so that it contains many valuable improvements. Even though High Fidelity—and the legion developments that go to make an acceptable “hi-fi” receiver—plays a stellar role in modern receiver design, supersalesmanship sometimes fails to convince the prospect that radio in the home, today, is better value, dollar for dollar, than ever before.

A \$7,500 “WIRED-FOR-RADIO” HOME

Now Radio-Craft offers new blood, in the form of an entirely original sales

plan, to revitalize the anemic radio industry. The plan opens a vast new market which gives the consumer radio reception in every room; and the dealer, jobber and manufacturer an undreamed-of outlet. These 2 factors are sufficient to create an immense installation and maintenance field for Servicemen.

Accordingly RADIO-CRAFT has under construction a \$7,500 1-family 5-room bungalow-type brick home—one which may be safely called an “Average American Home”—for the purpose of wiring it for radio.

In thus taking the initiative, we hope to forcefully bring this vast new radio market to the attention of not only the radio but also the building industries, as well as to the general public. Working closely with us are RCA Manufacturing Company, Inc., P. R. Mallory and Company, Inc., Birnbach Radio Company, and General Kontrolar Company, Inc.

Perhaps there’s a large question mark over your head about now—*what would be the total equipment, installation and operating cost of such a set-up? What about plans for a 6-room home, a 2-story home, etc.? Why hasn’t this plan been suggested until now? What about obsolescence?—other programs at the same time?—financing?*

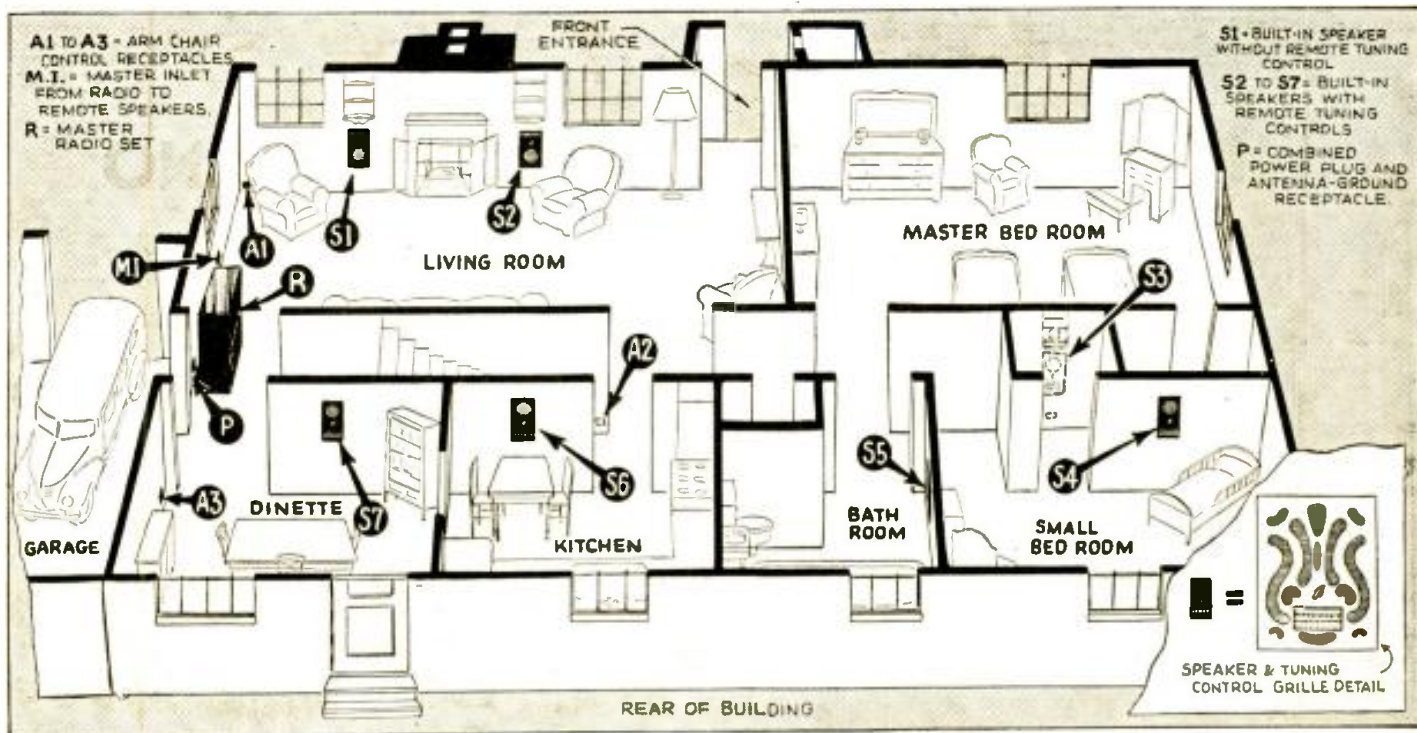

RADIO IN EVERY ROOM—FROM ONE MASTER RECEIVER!

Radio is as much an integral part of this home as are the lighting and heating systems—built-in at the time of construction. The master receiver can be pushbutton-tuned, turned on and off, and in every way controlled from each room. The volume of each speaker can be individually-controlled. The remote speakers and all switches will be mounted on a single hinged plate so that it can be swung out of the wall for future servicing.

—but let's start from the very beginning.

FACTS & FIGURES

If you've been riding in the country this past summer or reading the real-estate columns of your newspaper you probably noticed the tremendous amount of activity going on in the building line; entire blocks and neighborhoods being developed with modest 1- and 2-family residential homes, encouraged no doubt by the government F.H.A. plan. If you're skeptical, here are some official F.H.A. figures.

From January 1935 to September 1938 approximately 370,000 homes were bought! Of this number roughly 70 per cent were new homes. The total cash invested was over 1½ billion dollars—and for a period of only 3 years! There you have it. Yet there's a reason for this boom.

Never before were prices of homes so reasonable, the down payments so low, the financing so liberal, the time- and labor-saving improvements so numerous and the janitor-like duties of a home-owner so few. Yet with all these modern improvements, one, *more modern than any*, has been entirely forgotten—Radio.

Thus we hear of air-conditioning, automatic oil burners, efficient insulation against heat and cold, metal-case-ment windows, real brick fireplaces, brass pipe plumbing, electric door chimes, automatic gas and electric ranges and others, but not one word of Radio—*built-in* radio.

BUILT-IN RADIO

The reason! Builders, architects and prospective home owners are not aware of the fact that homes *can* be wired for

radio—at the time of construction. They are not aware of the fact that radio can (and should) be as much an integral part of the house as the plumbing, heating and lighting systems;— and it is up to the radio industry (R.M.A. please note) to point the way, to make the public so "built-in radio" conscious that if not automatically included in the house plans by the architect and builder, the "Wired for Radio" feature would be demanded by the prospective home owner.

Here then is our slumbering market! —homes wired for radio!

"Radio in every room" has long been the dream of every manufacturer, jobber and dealer who has had an eye for profits. It has also been the dream of every man, woman and child who listens to the radio. But, until the present day, it has been economically impossible—save for the very rich—because "radio in every room" meant from 3 to 7 complete receivers to a family;— each receiver with its own dangling aerial and line-cord wires to be tripped over and collect dust; each a piece of furniture with its problem of placement; each with its breakdown troubles and resultant repair expense; each adding to the monthly electric bill—and all to say nothing

of their initial cost. Now, however, the day has arrived when that dream can be made to materialize. For today *one* master receiver can be made
(Continued on page 443)



These are the major components of the built-in radio system. In the background is the beautiful RCA-Victor high-fidelity victrola-radio combination model U-130. In front of it are 6 (7 will be used) RCA P.-M. dynamic speakers; 6 Mallory-Yaxley pushbutton switches, multi-contact outlets, pilot light sockets, and combination power and combined "Ant.-Gnd." outlet; Birnbach 7-wire shielded cable; RCA-Victor master antenna; and relay for turning the set on and off, remotely.

The DynaTone

PHONO—RADIO—ELECTRONIC PIANO

RADIO-CRAFT here presents the first published, signed article, by the President of Ansley Radio Corp., on a new 4-in-1 electronic musical instrument. A tentative schematic circuit is released to "R.-C." readers for purposes of discussion.

ARTHUR C. ANSLEY

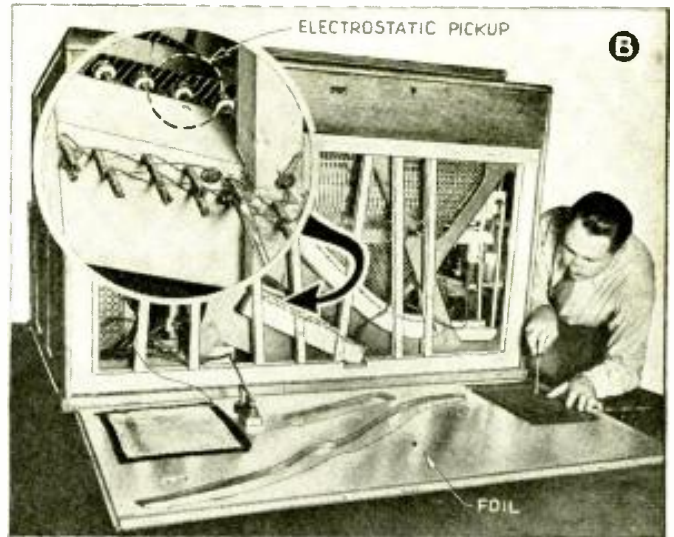
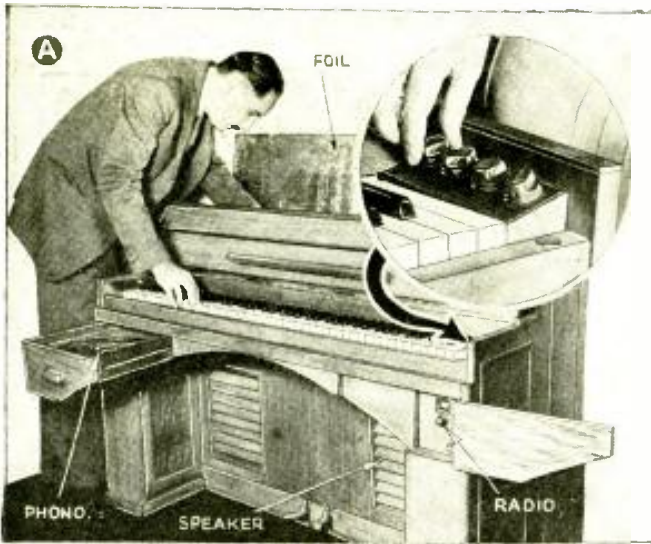

EVER since 1710, when the *piano-forte* began to supplant the *harpsichord*, the designers and technicians responsible for piano design have realized certain limitations which they have struggled to overcome. Fundamental among these limitations is the fact that the tone and volume, especially on the lower notes, is dependent on the mechanical energy produced by the vibrating strings.

Attempts to overcome this have led to the use of longer and longer strings and higher and higher tensions coupled to still larger sounding boards. These methods (of *mechanical magnification*—Editor) have reached their ultimate development in the modern *concert-grand piano* with its 9½-foot depth and enormous weight. Not many musicians

or music lovers, however, can afford the cost or would have the space for such an instrument in their homes.

ELECTRONIC MUSIC

When *electrical amplification* came into common use, engineers began to realize that there were possibilities of eliminating many of the limitations that had hampered the older musical instrument designers and of opening new fields in the production of musical tones. The work of these pioneers in electrical musical instruments took numerous roads with varying degrees of success.

One of the most promising lines of development was in the application of electrical pick-up of one kind or another to the vibrating strings of the

piano. This eliminated the necessity of the long strings, high tension, and large sounding boards that had formerly been necessary and removed the limitations of tone that had made the small pianos unsatisfactory to critical lovers of piano music.

DYNATONE

An instrument embodying these principles, and known as a *DynaTone*, has now been perfected and put into commercial form, and is meeting with the enthusiastic praise of professional musicians and the public alike. It embodies not only a *piano* using the highest developments of electrical amplification of the string tones, but also a *radio tuner*, and *phonograph pickup*

(Continued on page 433)

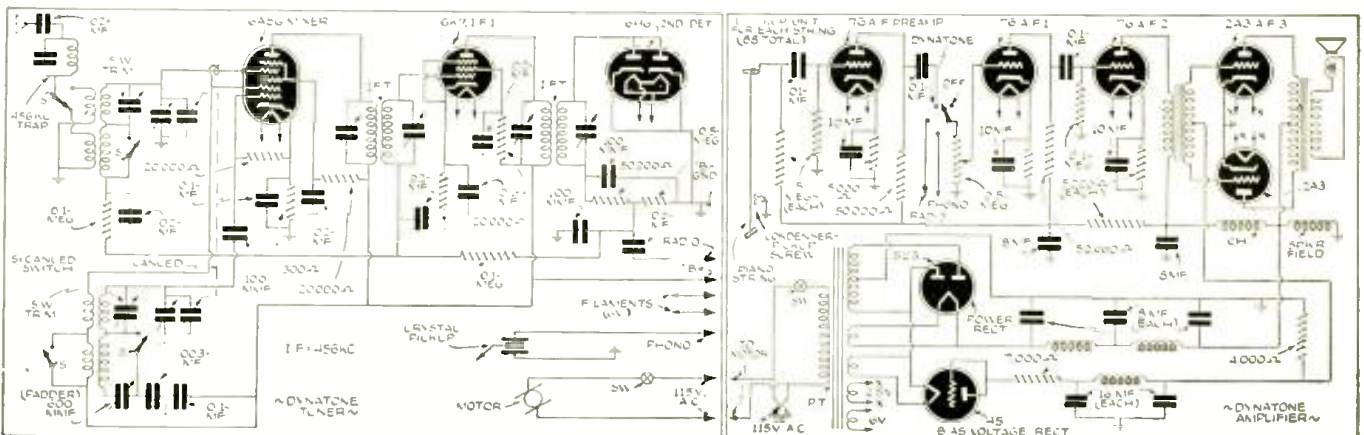

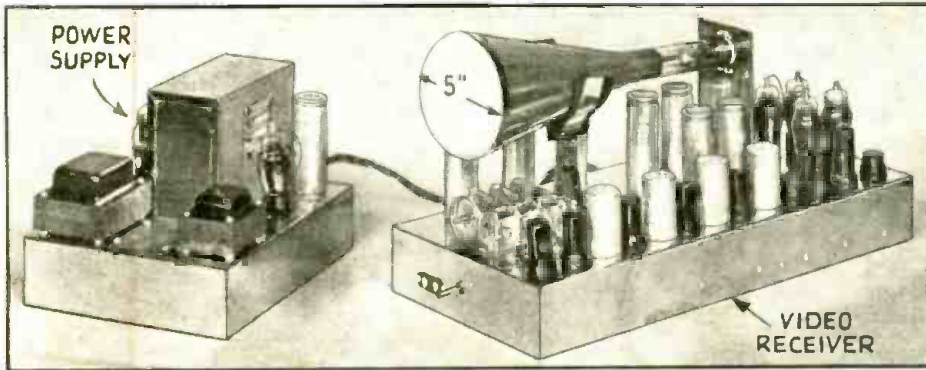

Fig. B. The 16-tube television receiver and its powerpack. The sound channel is not part of the kit but any ultra-H.F. set can be used. The C.-R. tube when housed as in Fig. A must be connected via flexible leads.

A TELEVISION KIT!

Description of America's first electronic television kit to be placed on the market. Uses a 5-in. C.-R. tube giving a 3 x 4 in. picture with good detail.



Fig. A. The Garod demonstration television receiver. The tube housing closes down with the lid.

It is a well-known fact that manufacturers spend money to make it—if that will help; so that when one of them suddenly comes out with a large television kit, we can be reasonably sure that television has definitely turned the corner. The kit, which is diagrammed (Fig. 1) and illustrated (Fig. B) on this page, was designed particularly for the amateur and ex-

perimenter desiring to pursue television as a hobby or career. A recent demonstration in New York City of a complete television receiver (Fig. A) designed around this kit, produced a fine picture 3 x 4 ins. on the screen of the 5-in. cathode-ray tube. The television receiver is designed to reproduce images scanned at 441 lines, interlaced, 30 frames per second. The images are

claimed to be bright enough not to require darkening the room when viewing.

The use of electrostatic instead of electromagnetic deflection of the cathode-ray beam greatly simplifies construction and helps keep down the cost.

Television is a constantly expanding field. More and more schools are adding television courses to their curriculum;

(Continued on page 441)

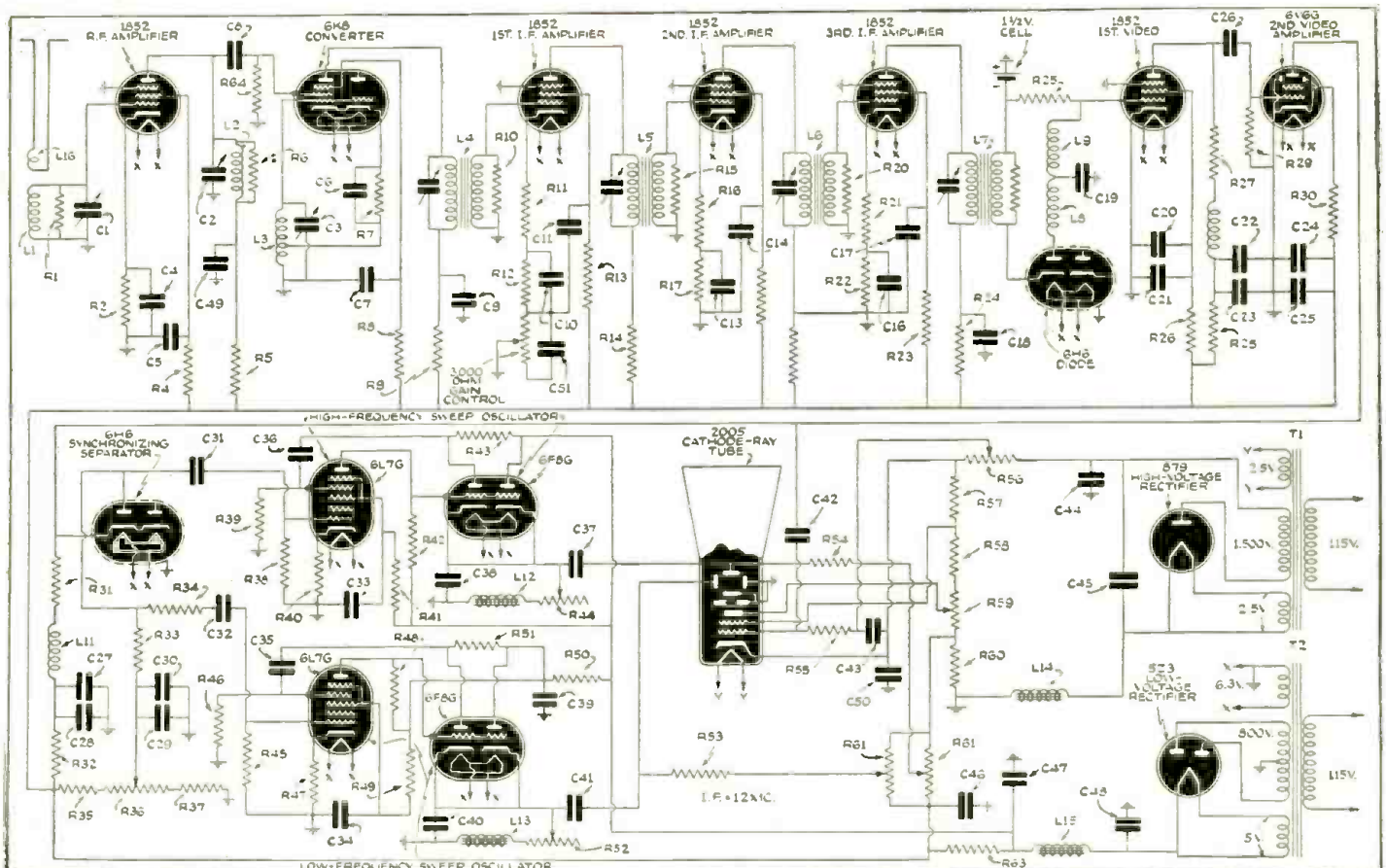

Fig. 1. Schematic diagram of the 16-tube video receiver. Note that electrostatic deflection is employed. The triode section of the 6K6 is not used.

- | | | | | | |
|-----------------------|-------------------------|------------------------|-----------------------|-----------------------|-----------------------|
| Resistors | R7—200 ohms, 1 W. | R15—1,500 ohms, 1/3 W. | R22—150 ohms, 1 W. | R29—2 megs., 1 W. | R35—40,000 ohms, 1 W. |
| R1—1,500 ohms, 1/3 W. | R8, R9—5,000 ohms, 1 W. | R16—10 ohms, 1/3 W. | R23—50,000 ohms, 1 W. | R30—50,000 ohms, 1 W. | R36—0.1-meg. pot. |
| R2—150 ohms, 1/3 W. | R10—1,500 ohms, 1 W. | R17—150 ohms, 1 W. | R24—5,000 ohms, 1 W. | R31—1,200 ohms, 3 W. | R37—0.25-meg. |
| R3—1,500 ohms, 1/3 W. | R11—10 ohms, 1/3 W. | R18—50,000 ohms, 1 W. | R25—1,500 ohms, 1 W. | R32—5,000 ohms, 10 W. | R38—0.5-meg., 1 W. |
| R4—50,000 ohms, 1 W. | R12—150 ohms, 1 W. | R19—5,000 ohms, 1 W. | R26—50,000 ohms, 1 W. | R33—25,000 ohms, 1 W. | R39—5 megs., 1 W. |
| R5—5,000 ohms, 1 W. | R13—50,000 ohms, 1 W. | R20—1,500 ohms, 1 W. | R27—2,000 ohms, 1 W. | R34—25,000 ohms, 1 W. | R40—1,000 ohms, 1 W. |
| R6—1,500 ohms, 1 W. | R14—5,000 ohms, 1 W. | R21—10 ohms, 1/3 W. | R28—5,000 ohms, 1 W. | | |

(Values continued on page 441)

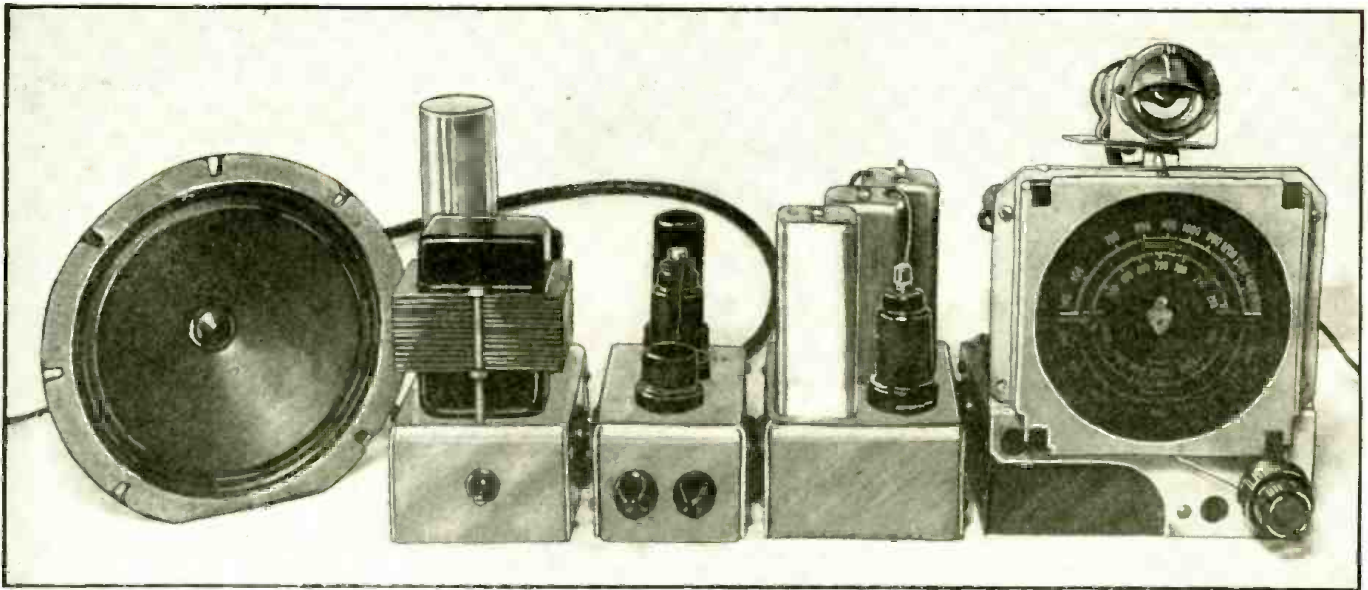

Fig. A. View of the completed receiver with each of its component units plugged together and all ready for operation.

MAKE THIS *Plug-Together*

The construction of a receiver for either broadcast or short-stability has almost always offered severe obstacles to those not mind, the construction of a broadcast receiver was undertaken which would also give the advanced technician the design prin-

AMONG the difficulties which usually confront the occasional set builder are hum, audio oscillation or motorboating, and R.F. or I.F. instability or howling. Of these, the last is probably the most annoying for there are few who have been able to achieve the required sensitivity without instability or resorting to factory engineered chassis and circuit components. After a thorough consideration of these difficulties, a method of construction was arrived at which satisfactorily reduced these to a minimum and at the same time contributed greatly toward the adaptability of the finished product.

THE PLUG-TOGETHER SYSTEM

A plug-together system was devised

in which a separate chassis was employed for each frequency division, viz.—power supply, A.F., I.F., and R.F. Using this system, a set of any type can be built up piecemeal and the full advantages of each section fully realized. In the case of the receiver recently completed, sensitivity was the prime requisite. Neither high power output nor high fidelity reception was desired although none save economic difficulties would have been encountered in their incorporation.

POWER SUPPLY

Therefore, a small power supply designed to deliver approximately 220 volts at 60-70 ma. was assembled on a chassis 3 x 4½ x 2 ins. high. This is

conveniently managed by using a space-saving metal rectifier tube. A 6X5 was on hand and answered the current and voltage requirements and was therefore employed. A small choke Ch.1 of the auto-set type and a dual 8 mf. filter condenser held the hum level within satisfactory bounds.

A unit of this type is handy in itself as a source of filament voltage and "B" voltage for various applications around the workshop.

LEWIS L.

A.F. AMPLIFIER

Next, an audio amplifier of low output was placed along with a 6H6 detector on an even smaller chassis, 2½ x

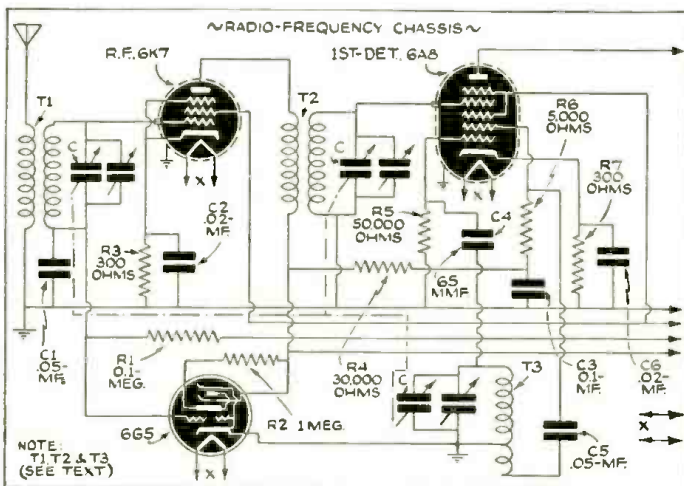

Fig. 1. Diagram of the R.F. unit.

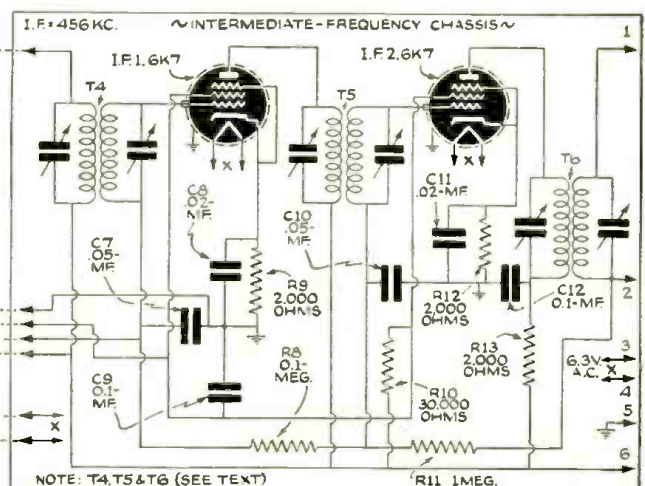

Fig. 2. Schematic of the I.F. unit.

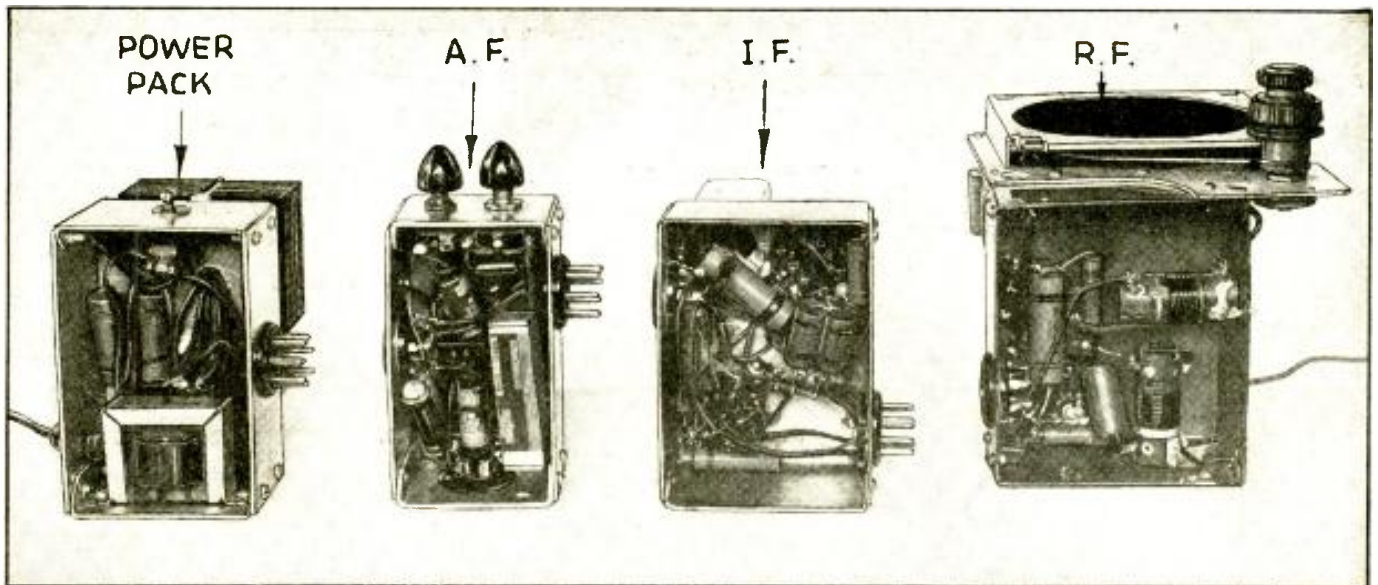

Fig. B. Beginners will welcome this novel radio set. Each of its basic units can "grow" in any way the builder desires.

8-TUBE A.C. RECEIVER

wave reception embodying in its design high sensitivity and thoroughly experienced in receiver design. With this thought in which the novice could duplicate with little or no trouble, and ciples of a highly flexible layout for any type of receiver.

SHARRARD

$4\frac{1}{2} \times 2$ ins. high. A 6F5, resistance-coupled to a 6F6, provided ample gain for either detector or phono-graph inputs. The unit, containing volume and tone controls, was found to be quite satisfactory when used in either of these applications. It might be noted here that the cathode bypass condenser was purposely omitted on the 6F6 to provide inverse feedback to reduce distortion. A male chassis plug on the power supply and a socket on the A.F. chassis provided easy means of connecting the units or for disconnecting them if separate uses were to be desired in the future.

I.F. AMPLIFIER

Obviously it was now necessary to add an I.F. channel in order that a tuner might be employed. Here was the critical stage where it was necessary that a high degree of sensitivity and stability be attained. Violating the precepts of conventional receiver design,

2 stages of hi-Q intermediate frequency amplification were mounted on a chassis only $3\frac{1}{2} \times 4\frac{1}{2} \times 2$ ins. high. These comprised 3 triple-pi-wound hi-Q I.F. transformers and two 6K7's. With this set-up on a separate chassis, very high gain was possible with no trace of I.F. oscillation and with but one decoupling filter—R13 and C12. This chassis connected by plug and socket arrangement to the A.F. chassis.

R.F. AMPLIFIER

Lastly an R.F. tuner was assembled on a chassis $4 \times 4\frac{1}{2} \times 2$ ins. high. A strictly conventional tuner circuit was used. Coils were taken from a medium-price receiver. By mounting the antenna coil on a bracket above the chassis and in a plane parallel to the chassis, the grid lead was made very short. The R.F. and oscillator coils were mounted beneath the chassis in planes at right-angles to one another still giving short leads. As a result, it was not necessary to shield the coils and thus detract from their gain. This unit was

connected to the I.F. channel by the same plug and socket arrangement and the set plugged-in.

The receiver was aligned on the air and found to have amazing sensitivity with no hint of oscillation and very little hiss. Later the sensitivity was measured on a Ferris 10B Microvolter and it was found that an input of as little as $\frac{1}{2}$ -microvolt would give an output of 50 milliwatts across the voice coil of the small permanent-magnet dynamic speaker used.

It was therefore felt that a convenient method of acquiring high sensitivity had been arrived at, for the only tools used in the actual assembly of the various units were a screwdriver and a pair of pliers, only the former being needed to provide satisfactory alignment.

FLEXIBILITY

Other advantages resulting from this type of design will be apparent to the advanced technician. Perhaps the most

(Continued on page 431)

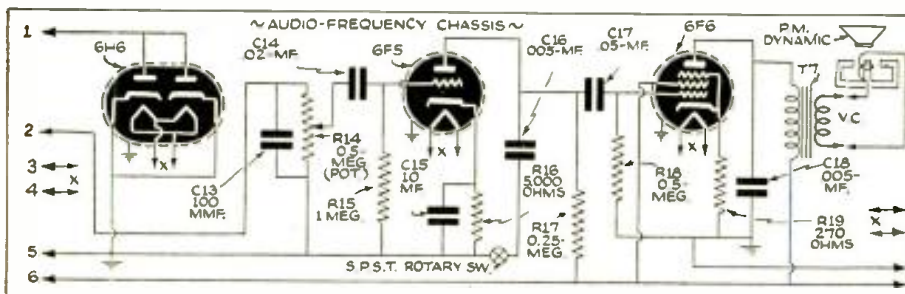

Fig. 3. Circuit arrangement of the A.F. unit.

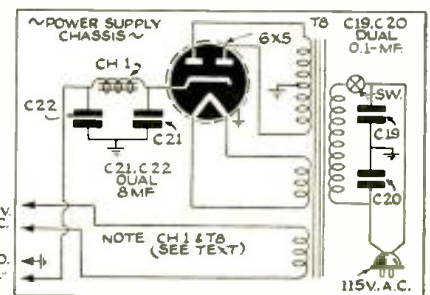
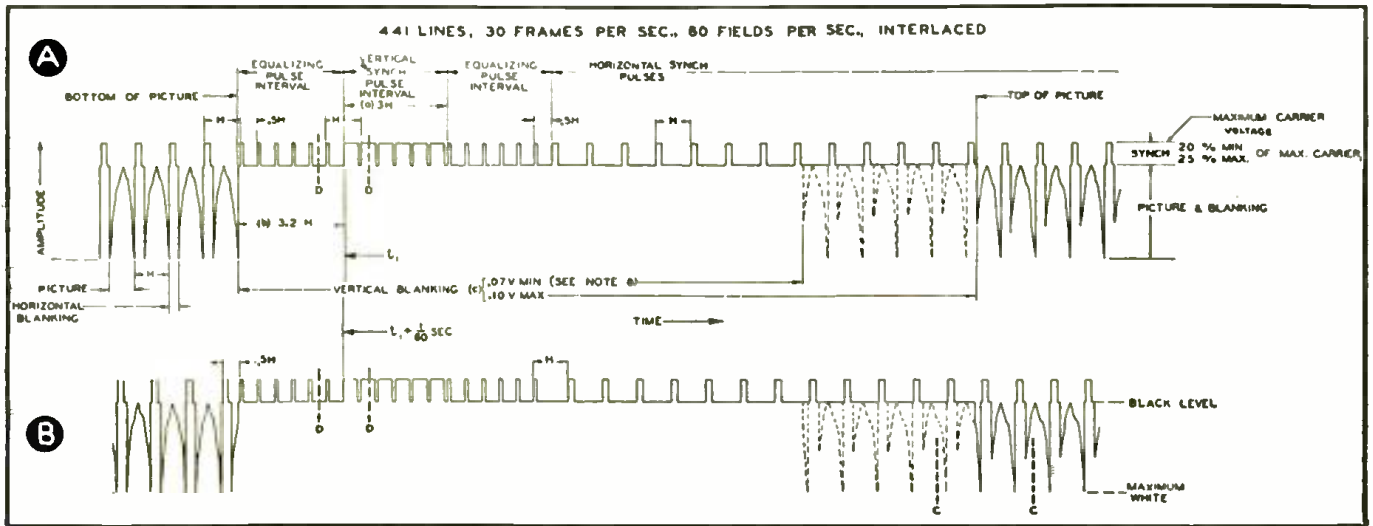

Fig. 4. Power supply diagram.

THE PROPOSED TELEVISION STANDARDS . . .

If recently proposed television standards are accepted by the F.C.C. it is be- even though licensed on an experimental basis. With a view to acquainting readers material recently released by the Radio Manufacturers Association; together with of International Television Radio Corp., which is representative of those



R.M.A. STANDARD TELEVISION SIGNAL

Fig. 1. A & B show blanking & synchronizing signals in regions of successive vertical blanking pulses. (Horizontal dimensions not to scale. All dimensions are from black level unless otherwise specifically indicated.)

SUGGESTIONS for more strict control of television experiments have been made by the Federal Communications Commission in a letter to Bond Geddes, executive vice-President of R.M.A.

After consideration by the R.M.A. engineering department and special television committee, the Association submitted last month a set of proposed standards for television transmission. The Commission's reply, made by Secretary T. J. Slowie, asked the R.M.A. to give the names of companies actively engaged in the development of television, the extent of such activity, and submitted other specific questions, as follows:

"Why it would be in the public interest to adopt the standards proposed by the R.M.A. at this particular time, including a statement as to whether television stations, even though licensed on an experimental basis, should be required to abide by such standards.

"Whether or not you believe that the development of television has reached the stage where the Commission might call formal hearings with respect to the adoption of standards, in which event the R.M.A. would be expected to present evidence showing that such standards are required at this particular time."

The questions raised by the Commission are now under advisement by the R.M.A. Engineering and Television Committees. In submitting the proposed television transmission standards, the R.M.A. advised the Commission that it was prepared to demonstrate that the proposed television standards are practical and in the public interest. These proposed standards are here printed and illustrated.

The R.M.A. television standards represent a tremendous amount of work of the best engineering and executive talent of the Association and the radio industry, covering a period of many months, with most difficult and complicated problems involved. A few television interests which are not technically among R.M.A. membership participated in the preparation of the proposed standards.

To handle the increasing amount of work by the R.M.A. on television, three new engineering committees are in process of formation by Dr. W. R. G. Baker of Bridgeport, Connecticut, chairman of the R.M.A. engineering department. The three new sub-committees are being appointed on (1) television interference, (2) television transmitters, and (3) television receivers. The respective sub-committee chairmen appointed by R.M.A. Chairman Baker are Messrs. J. E. Brown of Zenith Radio Corporation of Chicago, E. W. Engstrom of RCA Manufacturing Company of Camden, N. J., and I. J. Kaar of General Electric Company of Bridgeport, Conn.

PROPOSED TELEVISION TRANSMISSION STANDARDS

TELEVISION CHANNEL WIDTH

The standard television channel shall not be less than 6 megacycles in width.

TELEVISION AND SOUND CARRIER SPACING

It shall be standard to separate the sound and picture carriers by approximately 4.5 mc. This standard shall go into effect just as soon as "single side band" operation at the transmitter is practicable. (The previous standard of approximately 3.25 mc. shall be superseded.)

SOUND CARRIER AND TELEVISION CARRIER RELATION

It shall be standard in a television channel to place the sound carrier at a higher frequency than the television carrier.

POSITION OF SOUND CARRIER

It shall be standard to locate the sound carrier for a television channel 0.25-mc. lower than the upper-frequency limit of the channel.

POLARITY OF TRANSMISSION

It shall be standard for a decrease in initial light intensity to cause an increase in the radiated power. (See Standard M9-121.)

FRAME FREQUENCY

It shall be standard to use a frame frequency of 30 per second and a field frequency of 60 per second, interlaced.

NUMBER OF LINES PER FRAME

It shall be standard to use 441 lines per frame.

ASPECT RATIO

The standard picture aspect ratio shall be 4:3.

PERCENTAGE OF TELEVISION SIGNAL DEVOTED TO SYNCHRONIZATION

If the peak amplitude of the radio frequency television signal is taken as 100%, it shall be standard to use not less than 20% nor more than 25% of the total amplitude for synchronizing pulses.

METHOD OF TRANSMISSION

It shall be standard in television transmission that black shall be represented by a definite carrier level independent of light and shade in the picture.

SYNCHRONIZING

The standard synchronizing signals shall be as shown in Figs. 1 and 2.

. . . Are They Fair To All?

lieved that regulations would follow to require observance by television stations with certain of the factors on both sides of the story RADIO-CRAFT here presents a few comments, exclusive to "R.-C.," by the President and Chief Engineer companies having developmental plans not amenable to these "standards."

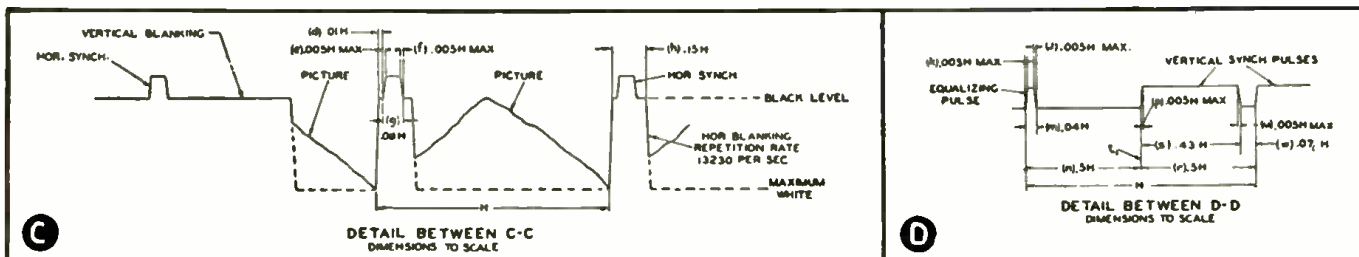

DETAILS OF R.M.A. STANDARD TELEVISION SIGNAL

Fig. 2. Diagram C shows enlarged detail view of signal in Fig. 1B between lines C-C. Diagram D shows enlarged detail view of synch. signal in Fig. 1A, between lines D-D. H-Time from start of one line to start of next line = $1/3230$ sec.; V-time from start of one field to start of next field = $1/60$ sec. = $220/2$ H; leading and trailing edges of both hor. and vert. blanking pulses have slopes (not indicated in A & B) which should be kept as steep as possible; receiver vertical retrace shall be complete at end of .07 V.

TRANSMITTER MODULATION CAPABILITY

If the peak amplitude of the radio-frequency television signal is taken as 100%, it shall be standard for the signal amplitude to drop to 25% or less of peak amplitude for maximum white.

TRANSMITTER OUTPUT RATING

It shall be standard, in order to correspond as nearly as possible to equivalent rating of sound transmitters, that the power of television *picture transmitters be nominally rated at the output terminals in peak power divided by 4.

RELATIVE RADIATED POWER FOR *PICTURE AND FOR SOUND

It shall be standard to have the radiated power for the *picture approximately the same as for sound.

*Radio-Craft prefers the term *image* to avoid confusion with facsimile operation wherein actual pictures (as compared with the evanescent image) are produced on paper. A *facsimile picture* could be hung on a wall; a *television image* could not be so mounted. This quite clear distinction has received the endorsement of many television specialists.—Editor.

DISCONTINUOUS SCANNING

The primary pattern of this art was that introduced by Nipkow. Of necessity it was a *linear discontinuous pattern*. (See Fig. 3A.) No time was lost between the beginning and the ends of lines, for the vanishing spot on one line marked the inception of the new spot on the next line.

When the cathode-ray school came along to strive for control of the field, its engineers adopted the same scanning pattern in an attempt to make the receiving sets interchangeable with the Nipkow sets, so that the cathode-ray sets could receive broadcasts from the latter's transmitting stations.

This introduced two problems. The first was that some of the time that the beam should remain active was lost due to the necessity of returning it to the initial position, a line or frame lower. The second was the necessity of developing an exact linear rise in current or potential in order to prevent distortion. Somehow the backsweep thus introduced has remained and the engineers are saddled with the job of creating a type of current or potential wave at violence to the ease of generating a wave that is a simple sine or a logarithmic oscillating rise or decay.

This established discontinuity introduced another unnecessary harmful factor, namely, eye fatigue. Try the "man on the street" on a cathode-ray image scanned in this manner and you will find that his eyes will quickly tire from this abuse.

CONTINUOUS SCANNING

A more logical pattern would be based upon some form where the beam is continuously upon the image. In a *linear continuous pattern* there is no interruption of the scan-line. (See Fig. 3B.) Naturally, numerous patterns can be designed, and several will find urgent supporters. I doubt if any pattern more unsound than the discontinuous linear pattern that the "standardization" men want, has yet been devised.

Then again, provision should be made in the early, introductory phases of television for transmitting the sound on the standard

(Continued on page 432)

Comments by WILLIAM H. PRIESS, Television Pioneer and Expert, on the Proposed Standards

It is most difficult for me to conceive of any group of technicians proposing a schedule of rigid standards for a whole art, whose apparatus is expressed by several solutions that follow widely diverse schools of thought. An art, wherein even each particular school has fundamental differences in apparatus or its operation, and such differences are emphatically defended by their several designing engineers.

I believe that somewhere a grave practical error is being made in ignoring the dictum, that standards are primarily established to conform an art to the realities disclosed by experience.

EXPERIENCE

It is naive, for example, for pants makers to yearn for the day when all pants will be of a like size, for humans are not built that way, and human experience will testify to this fact. Standards are not workable if they rest on any foundation other than experience. It is absurd to even contemplate the confining of an art that is still in the laboratory, to a set of artificial limitations that lack the background of broad experience in the field.

Home television is not a private toy of the scientists, but an art in the making, whose objectives are essentially public. We must therefore look at television through the public eye. It has little or no interest

in its technical aspects. What it wants is the end result, namely, a "picture," in the home, of the best possible quality, most desirable size and brilliancy, and a receiving set of the greatest durability, simplicity and stability; and one of this performance that can be bought at the lowest price. Naturally, it wants a set that will function on any of the several systems of television thought; but that is a conceded impossibility, somewhat like making a single pair of pants fit any and all customers.

The only group pressing for standardization in this country is limited to the cathode-ray men. Why? Are they blind to the experience gained from the large-scale commercial plunge taken by the British? Is it possible that they have not heard that the picture (image) size of these British sets is unsatisfactory, that their cost is too high and that only a small number of sets have been sold despite a costly and vigorous sales campaign? Or are they uncertain and attempting to maintain their perhaps crumbling dreams by standards that will freeze out competition?

Consider for the moment just one phase of this problem, namely the history and some factors that enter into a scanning pattern. Naturally the transmitter and receiving set patterns must be exact duplicates or there can be no picture (image) at all.

COMPLETE STEP-BY-STEP

What is Dynamic Servicing?—See how many of your associates in the service field increase your earning power by speeding your radio service work. This, Part I, out-setting-up cathode-ray test equipment for

PART I

KENDALL

WE all understand the term "analysis." In radio, it has grown to mean the orderly and systematic measurement of voltages and resistances in circuits of receivers and the various acts the Serviceman finds necessary to the isolation and elimination of circuit defects. But what is *dynamic* analysis?

Webster defines "dynamic" as "... involving or causing energy, motion, action or change." As applied to receivers, testing that "involves motion, action or change" is perhaps best illustrated by a familiar example:

Suppose we consider a tube in its socket and connected to all its associated circuits. If we measure the various socket voltages, then turn off the line power and measure the resistance or capacity from the socket terminals to ground, we have made a *static* analysis, or what is more commonly called a "point-to-point" test.

If, on the other hand, we leave the set turned on and apply a signal of suitable frequency to the grid of the tube, and measure the various effects of the signal upon the tube itself as well as on the circuits following, we have performed a "dynamic" (action or working) analysis instead.

DYNAMIC ANALYSIS SAVES TIME!

The purpose of dynamic analysis, of course, is to save time, and the tool that does this most efficiently is the *cathode ray*. Together, they examine or analyze the *working* condition of entire sections of a receiver at a glance, as against the difficult, slow progress of the static method. The following example will illustrate:

Let us consider the A.V.C. circuit of a modern radio receiver. Here, as you know, the volume control follows the 2nd-detector, and the purpose of the A.V.C. is to keep the R.F. signal applied to the 2nd-detector within bounds, so as to prevent distortion from originating and passing on through the audio amplifier and loudspeaker.

Suppose the receiver in question sounds distorted. It may be that the distortion is due to A.V.C. failure as suggested above, or perhaps it lies in the audio amplifier or speaker.

Just pick up the diagram of any modern receiver and see how many points have to be identified and measured in order to come close to finding a solution by static method! Further, what a job

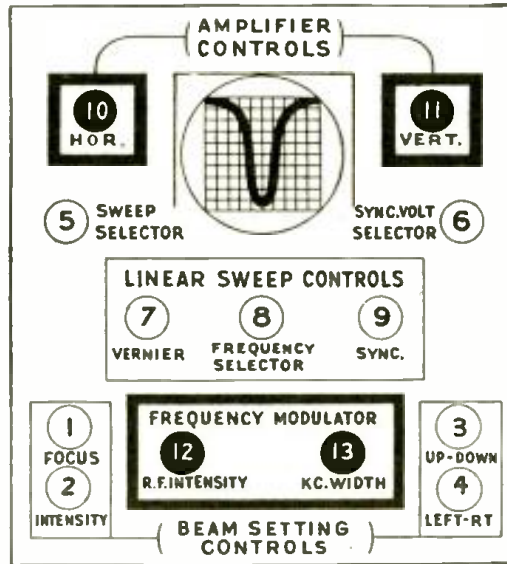

Fig. A. The controls of the Clough-Brengle No. 127 "Graphoscope," a typical Serviceman's oscilloscope, divide into 4 easily-learned groups.

is the identification of such points, especially under the handicap of scanty service information, as so often is the case,—and with more tube basing arrangements in use than can possibly be memorized!

By contrast, dynamic analysis, performed with cathode-ray equipment, tests first the entire speaker, next the speaker and audio amplifier together, and third the A.V.C. system joined to both. And for each test there is a cathode-ray pattern that says "Trouble Here," or "Not Here" (as the case may be), without having to go into the maze of parts which make up the function under test.

Is it any wonder that dynamic analysis with cathode-ray equipment saves time?

MEET MR. CATHODE-RAY OSCILLOSCOPE

Equally as important, you don't have to have a college degree to learn com-

plete dynamic testing with cathode ray apparatus in short order. The method is simple and so is the instrument, as you'll find out, as soon as you get acquainted. Furthermore, you'll be spared all theory, but receive only definite and direct instructions which anyone can follow who is able to read a receiver diagram.

First, shake hands with the "C.-R." instrument, or cathode-ray oscilloscope:

Actually, an oscilloscope is nothing more than a sensitive *high-impedance voltmeter* in which a beam of electrons is substituted for the needle. Imagine this needle pointing toward you through a window and leaving on the glass a momentarily visible phosphorescent trace, as it responds to the various changes in voltage or current direction and intensity applied to it, and you have a perfect conception of what actually takes place.

Movement of the beam is effected vertically or horizontally through 2 correspondingly designated pairs of *deflecting plates* to which voltages or currents are applied through built-in amplifiers, or directly, as desired.

Operation of the instrument and how it is used to save time in dynamic analysis of receivers from antenna to ground will be most readily comprehended and understood through actual, practical work on receiver servicing, as subsequently directed.

The oscilloscope here selected to demonstrate the work-a-day application of cathode-ray dynamic analysis is the new C-B "Graphoscope" No. 127, in which is incorporated a uni-signal frequency modulator. The name uni-signal implies delivering only the wanted signal, free from harmonics, and so completely doing away with time-wasting error and confusion.

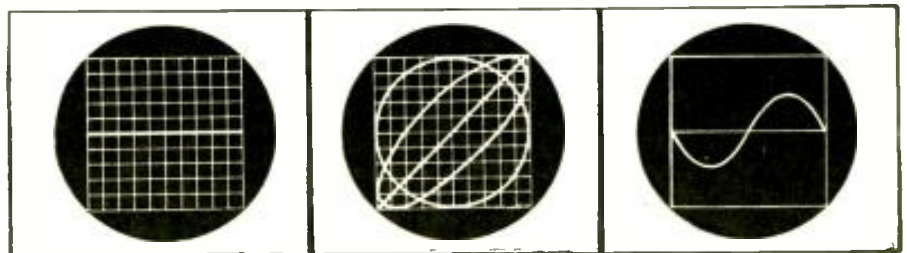

Fig. 1A. Trace properly centered and adjusted, using control knobs 1-2-3-4. Fig. 1B. Patterns observed while becoming familiar with the controls. Fig. 1C. 60-cycle wave, 60 sweeps per second.

DYNAMIC SERVICING

can answer this question! Then read this article and see how this test procedure can lines the entire subject and, in Section 1, describes in complete detail the manner of best results in making Dynamic analysis.

CLOUGH

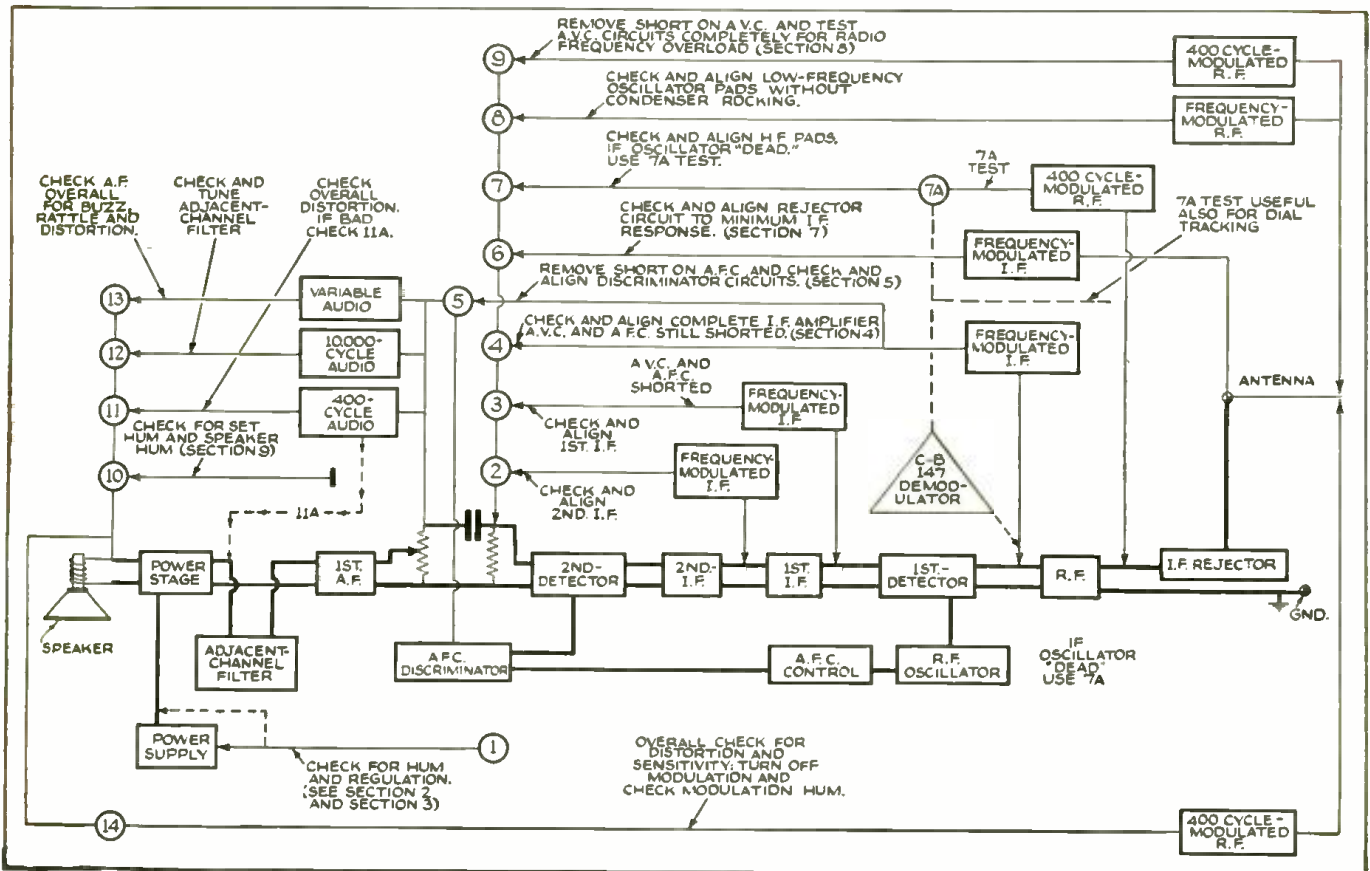

Fig. B. Block diagram of a typical modern radio receiver showing, step-by-step, the broad plan of dynamic testing with a modern cathode-ray oscilloscope.

2 MAJOR CONTROLS

In approaching an oscilloscope, don't be misled or confused by the number of controls. Most of these—all but 4, in fact—are merely pre-adjusters, to give the instrument its preliminary setting. And of the 4 working controls, 2 are but little used, so that actually only 2 major controls do most of the work. Figure A, which shows the controls of a typical oscilloscope as they actually divide themselves into 4 easily-learned groups, makes the underlying sim-

licity of the control arrangement quite apparent.

PRE-ADJUSTMENT CONTROLS

- For setting beam—1, 2, 3, 4
- For selecting sweep source—5
- For setting synchronizing voltage—6
- For selecting desired trace—7, 8, 9

WORKING CONTROLS

- For size of trace—10, 11
- For frequency modulation—12, 13
- Of the latter, 10 and 13 are but little used, 11 and 12 doing most of

the work throughout the various steps of testing.

As your index to the broad plan of dynamic testing through the instrumentality of the cathode-ray, see Fig. B, a block diagram of a modern radio receiver. Not all receivers have all the features shown, but when you do get such a model you'll want to be ready for it, and confident. For simpler models you will leave out, of course, tests that do not apply.

14-POINT DYNAMIC TESTING RAISES SERVICE FEES

Wherever possible, you will want to make every test, to check up on your work and to assure your customer a perfect job—but, *get paid for it!*

Selling 14-POINT CATHODE-RAY CHECK-UP is an easy job and one that rests on a truly solid foundation of finer performance and increased customer enjoyment and satisfaction.

Your customer has already been educated by the automobile industry that
(Continued on page 434)

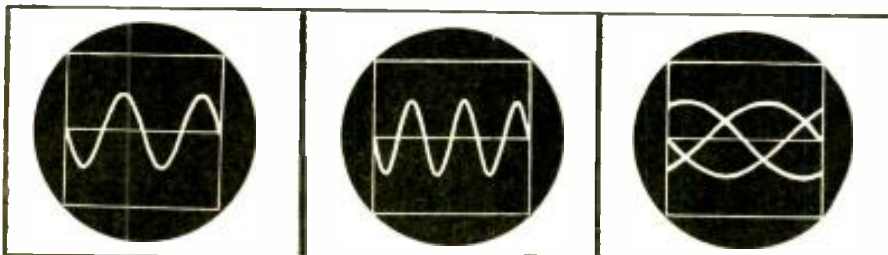

Fig. 1D. 60-cycle wave, 30 sweeps per second.

Fig. 1E. 60-cycle wave, 20 sweeps per second.

Fig. 1F. Wrong sweep adjustment; 3/2 rate.

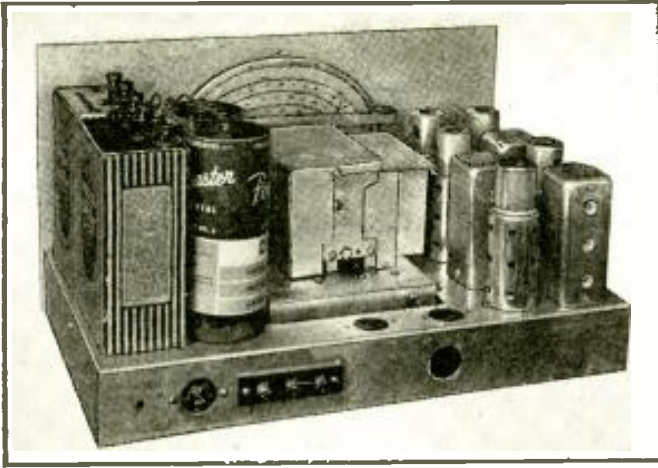

Fig. B. Rear view of the 6-tube battery receiver.

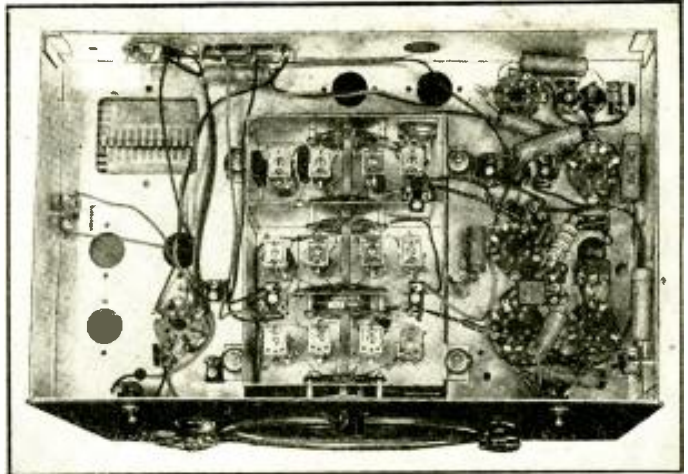

Fig. C. The tuner is mounted in center of chassis on rubber grommets.

"FARMER'S FRIEND"—A 6-Tube

The introduction of the new 1.4-volt tubes makes it possible for those not operated without undue strain on the pocketbook. Furthermore the receiver



Fig. A. The panel arrangement of the economical 6-tube, 1.4-V. battery set. Range 0.54 to 22 mc.

WITH the advent of the new 1.4 volt series of tubes consuming only 50 ma. filament current and requiring only 90 volts plate battery, the design of an economical 4-band super. which would perform comparable to an A.C.-operated job became possible.

ECONOMY

These new tubes which have recently been announced by Raytheon and a number of other manufacturers are so designed that no "C"-battery bias is required except in the case of the power tube. Utilizing the 1C5G tube, 0.24-watt can be supplied to a speaker, which is sufficient to drive the new permanent-magnet, dynamic-type speakers so that ordinary room volume is obtained. The receiver is shown in Figs. A, B and C, above.

If economical operation is to be obtained from drycells, it is absolutely essential to limit the number of tubes to those necessary for performance. With this in view, the 6-tube receiver to be described in this article was designed by the writers.

With the 6-tube receiver shown, the total "A" battery current is 350 ma. This is sufficiently low so that two

No. 6 drycells connected in parallel will last 4 or 5 months with normal use. The total "B" battery current drain is about 17 ma. Using medium-size "B" batteries, 6 to 8 months service may be expected under normal use of 3 or 4 hours a day.

FEATURES

The receiver covers a frequency spectrum of from 0.54-megacycle to 22 megacycles in 4 bands. It employs a stage of radio frequency amplification on all bands. This is essential from the standpoint of image rejection, high signal-to-noise ratio and sensitivity. Two stages of I.F. amplification are used as the 2nd stage adds materially to the sensitivity.

A pentagrid converter tube, the 1A7G, is used as both an oscillator and a mixer tube, while a combination tube, the 1H5G is employed as both a diode detector and a 1st stage audio amplifier.

CATACOMB

A tuning *catacomb* which is wired, aligned, and tracked at the laboratories is used as the heart of the receiver. This tuning *catacomb* incorporates coils for a tuned antenna circuit, a stage of radio frequency amplification and oscillator circuit together with their associated trimming and padding condensers for each of the 4 bands covered. The coils for the various circuits are sectionally segregated by shielding. A 3-gang tuning condenser enclosed in shields is mounted on the upper portion of the tuning *catacomb*. This tuning *catacomb* is isolated from the main chassis in order to reduce chassis currents to a minimum which results in an exceptionally fine signal-to-noise ratio. Soft rubber grommets are used for mounting supports which materially

G. H. BROWNING

aid in reducing mechanical vibration of condenser plates which might otherwise result in mechanical acoustical feedback. No tube sockets, etc., are mounted on the tuning *catacomb* since this would defeat one of the main purposes of this construction in allowing chassis currents to be generated within the tuning *catacomb*.

CIRCUIT

The circuit diagram of the receiver utilizing 6 tubes and two stages of I.F. amplification is shown in Fig. 1. (A single stage I.F. may be used if desired, making the receiver a 5-tube set.)

It will be noted that band-pass I.F. transformers have been employed. These give a flat-top resonance curve which results in fine adjacent-channel signal rejection and at the same time gives a better audio frequency response characteristic than would otherwise be the case since the higher audio frequencies are very much less attenuated than in the case of using a double-tuned transformer.

SELF-CONTAINED

The chassis used for the receiver is ample in size so that the wiring of parts is greatly facilitated. In fact, there is sufficient room so that the two 45-volt "B" batteries and the two No. 6 drycells can be placed on the chassis allowing the complete receiver to be housed in a metal cabinet (see Fig. B). This makes the receiver very useful when portable operation is desired.

The sensitivity of the receiver with the 2-stage I.F. amplifier is substantially uniform over the 4 bands covered, being approximately 10 micro-

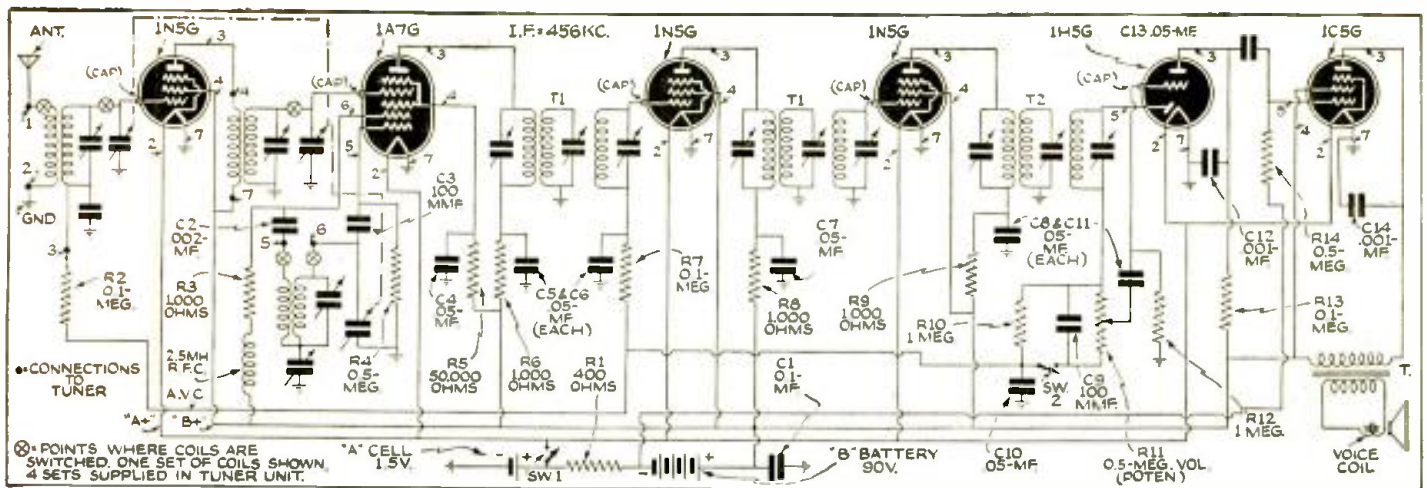

Fig. 1. Schematic circuit of the "Farmer's Friend" 6-tube superheterodyne. The entire filament consumption is only 50 ma.; and only 90-volts of "B".

Super. Using New 1.4-V. Tubes

having A.C. power to build an efficient, 4-band kit-type receiver which can be described may be readily converted for A.C. operation by adding a power supply.

and F. J. GAFFNEY

volts for 50 milliwatts signal output.

Automatic volume control is obtained from the voltage developed by the incoming signal across the 0.5-meg. volume control. On very weak signals the A.V.C. may be eliminated to advantage by means of the switch Sw.2, which connects the 1-meg. resistor to ground thus turning off the A.V.C.

CONSTRUCTION

The actual construction of the receiver is simplicity in itself. There are only 7 connections to be made to the tuning catacomb and 1 ground connection. The location of the tubes has been laid out so that all the leads carrying the high-frequency current are minimum in length and are correctly placed with respect to their associated apparatus. It will be noted from Fig. 1 that the circuit employed is a tried and proven one with no critical adjustments. As grid No. 3 of the 1A7G is parallel-fed and operates satisfactorily with approximately 85 volts, it is necessary to employ a radio frequency choke in conjunction with a 1,000-ohm resistor. The radio frequency choke used is 2½ mhy.

The layout of the component parts for the receiver is shown in the photograph, Fig. B. In assembling the receiver, it will be found advisable to first mount the tube sockets and I.F. transformers on the chassis. Tube shields must be employed with the 1A7G, the three 1N5G's, and the 1H5G tubes. The shield bases are held above the chassis by the same screws which hold the tube sockets below the chassis.

When the mounting of these parts has been completed, all filament, plate

and other wiring not requiring resistors or condensers should be completed. The resistors should then be connected carefully to keep all leads as short as possible. Resistors are ordinarily furnished with 2- or 3-inch leads to permit their adaptability for many types of installations. In assembling resistors in place, however, these leads should be cut to a length which is just sufficient to permit their mounting. This applies to condensers. The 0.002-mf. and the 100 mmf. condensers from the 2nd and 1st grids, respectively, of the 1A7G tube should not be mounted in position until after the tuner is in place.

When all of the circuit wiring has been completed, the tuner may be placed in its position in the chassis. The tuner is mounted on 4 rubber grommets which completely insulate it from the chassis. Precautions should be taken so that the tuner is electrically isolated from the main chassis. This is important in the maintenance of a high signal-to-noise ratio and maximum receiver performance. When the tuner has been mounted in position, it is only necessary to make 7 soldered connections to it including a ground in order to complete the wiring of the receiver. Two of these connections are to the 0.002-mf. and 100 mmf. condensers previously mentioned. These condensers should be soldered to the appropriate contacts on the 1A7G tube socket and the other terminals connected to the tuner by means of rigid copper wires (No. 18) which should be covered with spaghetti. It is important that the position of these condensers remain fixed when the receiver is in operation since any change in position will affect the tuning and alignment of the receiver. The ground connection on the tuner, which consists of a heavy copper braid, should then be soldered to the main

chassis making sure that a good connection is obtained.

When the receiver has been completely wired and the tuner placed in its position, the dial may be mounted on the tuner chassis. The dial is held in position by means of 2 self-tapping screws which hold the dial bracket to the tuner chassis. A setscrew holds the hub of the dial to the main shaft of the tuning condenser. In mounting the dial, it is essential that no pressure be brought to bear on the condenser shaft when the dial mounting screws are tightened.

When the dial has been mounted in place, the dial escutcheon may be mounted on the front panel and the panel may then be mounted on the chassis and held in place by means of the lock nuts on the controls whose shafts protrude through the front of the chassis. In mounting the panel, precautions should be taken so that the dial pointer does not hit the panel or the dial escutcheon. Since the dial pointer is in electrical contact with the tuner chassis through the dial mechanism, noise will be introduced on the high-frequency bands if the dial pointer is allowed to touch components mounted on the main chassis. Front view of the set is shown in Fig. A.

I.F. ALIGNMENT

The intermediate frequency transformers which are tuned to a frequency of 456 kc. are adjusted at the factory to this value. Due to position of leads on the chassis, however, slight adjustments will be necessary on the completed receiver. These adjustments may be made by connecting a short antenna and tuning in a weak station on the broadcast band and adjusting the top and bottom screws on the two T's and

(Continued on page 438)

MAKING A SERVICEMAN'S TEST UNIT THE "SUPER-GENO-SCOPE"

Here in compact, portable form is a combined oscilloscope, and R.F., I.F., A.F., and modulated (and wobbled) -R.F. and -I.F. oscillator, complete with power supplies. This unit permits visual analysis of any radio set's R.F., I.F., and A.F. circuits.

PART II

CANIO MAGGIO

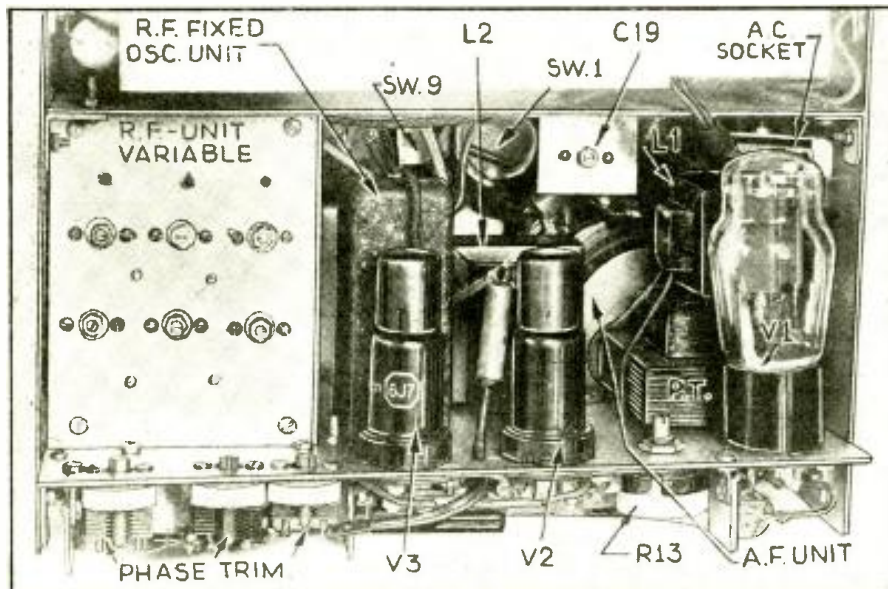

Fig. C. Back view of the Super-Geno section of the test unit. The chassis above is that of the Scope section described in Part I.

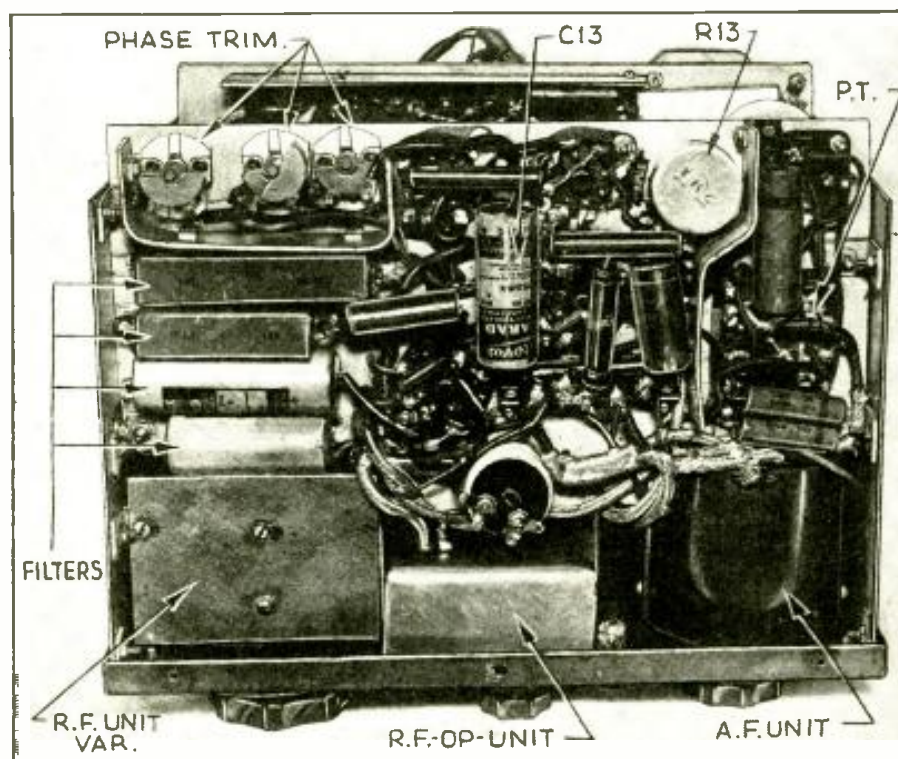

Fig. D. Bottom view of the Super-Geno section. Compactness is the keyword, deft soldering the key! Use only the parts recommended in the List of Parts.

THE SUPER-GENO section of this compact, convenient service instrument—Part I of which described, last month, the Scope (oscilloscope) section—is a multiple signal generator comprising a radio-frequency oscillator, a fixed-frequency oscillator, a variable audio-frequency oscillator and a frequency modulator. More detailed specifications follow. (See Fig. 2.)

- (1) The variable R.F. oscillator when heterodyned with the fixed R.F. oscillator has an output frequency from 85 to 32,000 kc., covered in 6 bands.
- (2) The fixed R.F. oscillator has a tuned frequency of 900 kc.
- (3) The A.F. oscillator has a frequency range from 50-7,000 cycles, covered in 11 steps.
- (4) The frequency modulator has a variable channel width from 0 to 30 kc., or 15 kc. at either side of the mean frequency.

HETERODYNE OSCILLATOR

Before proceeding with the construction details of the Super-Geno let us see why the output frequency is a heterodyne.

Early types of superhet. receivers employed in the majority of instances an I.F. of 175 kc. Modern supers., on the other hand, have intermediate frequencies that lie within a wide range in order to accommodate the special requirements of all-wave operation, car-radio reception, etc.

Introduction of the oscilloscope fostered development of a new method of alignment employing the "frequency modulation" principle, or *wobulation* (as it is also called), with a special oscillator (or "wobler") to supply the required modulation frequency.

However, a single-oscillator type of frequency-modulated signal generator does not possess an equal channel width throughout the band which it covers.

To overcome this disadvantage radio engineers have adopted the "beat-frequency" principle or the *heterodyne* (as it is also known); that is, the signal generator consisting of 2 oscillators, one a fixed-frequency and the other a variable-frequency type.

The fixed R.F. oscillator consists of the 6J7 oscillator tube and its associated inductances L3-L4, condensers C15-C20-C14, and resistor R7. (See schematic diagram, Fig. 2.)

The fixed oscillator being our frequency standard, it is absolutely important that every precaution be taken in its design and construction.

Pick-up coil L4 coupled to the oscillator tank circuit transfers the oscillator voltage or energy to the hexode control-grid (J3) of the 6K8. The grid coil L3 circuit is not of the conventional type but actually it is a double circuit: (1) the conventional grid circuit of the oscillator and (2) the

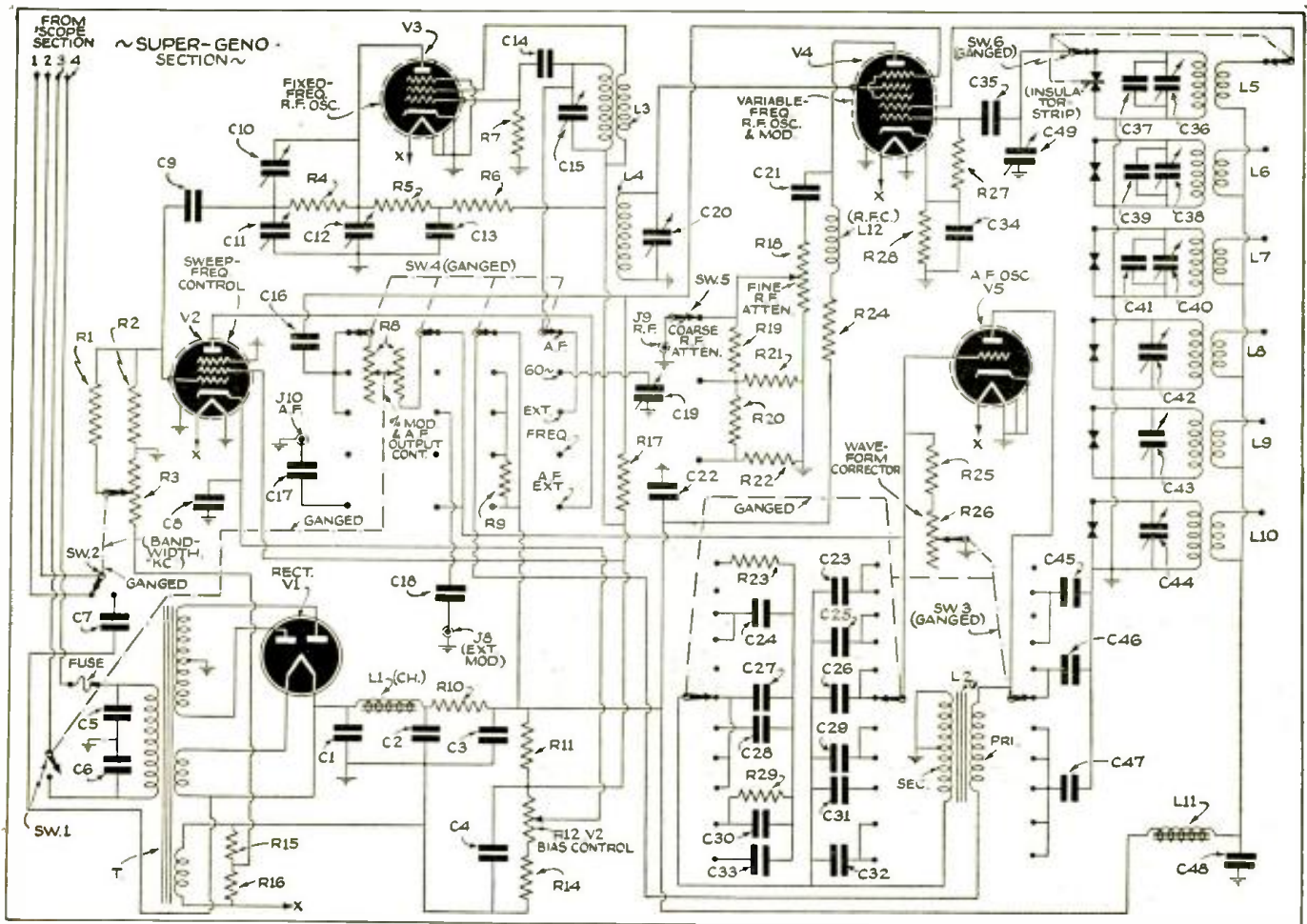

Fig. 2. Schematic diagram of the Super-Geno section of this Serviceman's test unit. Tubes: V1, 80; V2, V3, 6J7; V4, 6K8, V5, 6C5.

Resistors	R10—10,000 ohms	R20—6,000 ohms	Condensers	C10—50 mmf.	C20—50 mmf.	C30—0.002-mf.	C40—25 mmf.
R1—1 meg.	R11—20,000 ohms	R21—300 ohms	C1—10 mf.	C11—25 mmf.	C21—0.01-mf.	C31—0.05-mf.	C41—50 mmf.
R2—1 meg.	R12—15,000 ohms	R22—100 ohms	C2—8 mf.	C12—50 mmf.	C22—0.1-mf.	C32—0.25-mf.	C42—25 mmf.
R3—10,000 ohms	R13—0.5-meg.	R23—10,000 ohms	C3—8 mf.	C13—4 mf.	C23—0.002-mf.	C33—0.25-mf.	C43—25 mmf.
R4—6,000 ohms	R14—0.25-meg.	R24—35,000 ohms	C4—4 mf.	C14—200 mmf.	C24—0.006-mf.	C34—0.1-mf.	C44—25 mmf.
R5—50,000 ohms	R15—50 ohms	R25—30,000 ohms	C5—0.05-mf.	C15—50 mmf.	C25—0.006-mf.	C35—200 mmf.	C45—0.01-mf.
R6—50,000 ohms	R16—150 ohms	R26—20,000 ohms	C6—0.05-mf.	C16—0.05-mf.	C26—0.01-mf.	C36—50 mmf.	C46—0.05-mf.
R7—0.25-meg.	R17—0.1-meg.	R27—0.25-meg.	C7—0.25-mf.	C17—0.1-mf.	C27—0.01-mf.	C37—300 mmf.	C47—0.15-mf.
R8—0.1-meg.	R18—25,000 ohms	R28—300 ohms	C8—10 mf.	C18—0.05-mf.	C28—0.001-mf.	C38—50 mmf.	C48—0.1-mf.
R9—50,000 ohms	R19—1,000 ohms	R29—10,000 ohms	C9—0.001-mf.	C19—75 mmf.	C29—0.025-mf.	C39—100 mmf.	C49—250 mmf.

plate circuit for the frequency-control tube. When frequency modulation is employed, the frequency of the fixed oscillator is being varied at a constant rate. The rate of change is controlled by a frequency-control tube. The control tube varies the inductance of coil L3.

Due to circuit design of the fixed R.F. oscillator the 6J7 is used as a triode and the plate element of the tube is the coupling element between the frequency control tube and the fixed R.F. oscillator.

The variable oscillator is the triode of the 6K8 and the generated frequency is covered in 6 bands. All the oscillator components are encased in a heavy aluminum shield totally separated from other circuits, and thus are free from stray radiation or intercoupling between circuits. The tuning assembly or oscillator components are the 6 inductances L5-L6-L7-L8-L9-L10 and trimmers C36-C38-C40-C42-C43-C44, shunt condensers C37-C39-C41, tuning condenser C49, and band switch Sw.6. Special design of the latter eliminates absorption (leakage) which has a tendency to introduce frequency instability.

The hexode of the 6K8 is the modulator or mixer. Grid G3 is inductively coupled to the fixed oscillator; and G2-4, the hexode screen, is the modulating element for amplitude (A.F., 60-cycle, or external) modulation. Control R8, a constant-impedance attenuator, varies the modulating signal

without altering the impedance of either the input or output circuits.

The plate load of the modulator is a combined resistor R24 and inductance L12, capacity-coupled through C21 to a voltage divider circuit R18-R19-R20-R21-R22-Sw.5-J9.

The A.F. oscillator utilizing a 6C5 metal tube, V5, is somewhat different from the conventional type of oscillator.

It is economical, compact, delivers a high voltage, and has a sine wave output characteristic equal to that of a precision-type beat oscillator.

The audio oscillator is of the variable frequency type. The selection of any one frequency is controlled by rotary switch Sw.3. This unit is a 12-position, 3-pole rotary switch of which 11 taps are used for the various frequencies and the 12th tap is the OFF position.

TABLE II—SOCKET VOLTAGES

SUPER-GENO—
V1—plates, 325 volts.
V2—plate 85 volts, screen-grid 90 volts, cathode, ground or 0 volts.
V3—plate voltage same as S.-G. voltage before load R5-6 (The effective voltage cannot be read on a 0-1 ma. meter.); screen-grid 90 volts, cathode voltage is positive (Vary value of R13 until proper phase relation is established).
V4—plate (hexode) 200 volts, screen-grid

(G2-G4) 50 volts, cathode 1.3 volts, triode plate, 100 volts.
V5—plate, 170 volts.

LIST OF PARTS
("SUPER-GENO" SECTION ONLY)

- CONDENSERS**
One Aerovox, 10 mf., 450 V., C1;
Two Aerovox, 8 mf., 450 V., C2, C3;
Two Aerovox, 4 mf., 200 V., C4, C13;
Five Aerovox, 0.05-mf., 400 V., C5, C6, C16, C18, C46;
One Aerovox, 0.25-mf., 400 V., C7;
One Aerovox, 10 mf., 35 V., C8;
One Aerovox, 0.001-mf., C9;
Six Hammarlund variable trimmers, 50 mmf., C10, C12, C15, C20, C36, C38;
Five Hammarlund variable trimmers, 25 mmf., C11, C40, C42, C43, C44;
Two Solar, 200 mmf., C14, C35;
Three Aerovox, 0.1-mf., 400 V., C17, C22, C48;
One Hammarlund variable trimmers, 75 mmf., C19;
One Aerovox, 0.01-mf., 400 V., C21;
One Aerovox, 0.002-mf., C23;
Two Sprague, 0.006-mf., 200 V., C24, C25;
Two Sprague, 0.01-mf., 200 V., C26, C27;
One Sprague, 0.001-mf., 200 V., C28;
One Sprague, 0.025-mf., 200 V., C29;
One Sprague, 0.002-mf., 200 V., C30;
One Sprague, 0.05-mf., 200 V., C31;
(Continued on page 440)

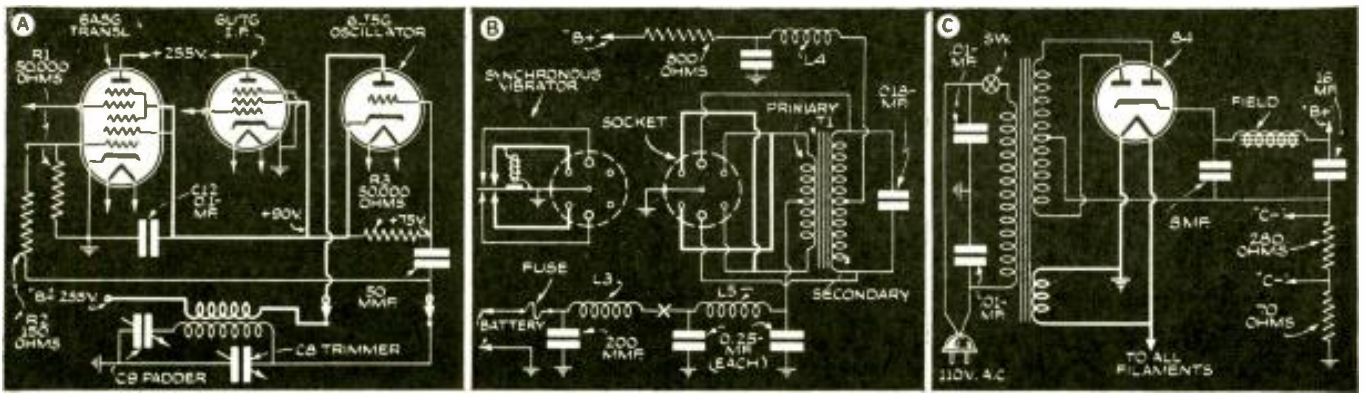

Fig. 1. New circuit features in Silvertone, Wells-Gardner and Philco receivers. The heavy lines accentuate the points discussed in the text.

NEW CIRCUITS IN MODERN RADIO RECEIVERS

The details of the modern radio receiver circuits that make them "different" from previous designs are illustrated and described each month by a well-known technician.

F. L. SPRAYBERRY

NUMBER 16

(1) OSCILLATOR PLATE CIRCUIT ACTS AS SCREEN BLEEDER

Silvertone Chassis 101.537. *Doing away with a screen-grid series voltage supply resistor or a screen-grid voltage divider, both of which waste power, the oscillator plate circuit furnishes this purpose.*

The plate of the oscillator is supplied as in Fig. 1A directly from the common high-voltage supply to all plates, through the plate coil. The actual plate-to-cathode voltage of the oscillator is the drop from the high voltage to the screen-grids or 255 to 90 volts, a total difference of 165 volts. The only wasted energy in this circuit is plate and screen-grid heat dissipation, which would be the same with any circuit.

(The drop to 90V. is due to the internal resistance of the 6J5G.—Editor)

(2) SYNCHRONOUS VIBRATOR POLARITY CORRECTION

Wells-Gardner Models C6-A, C6-B. *Provision is made for reversing the position of the vibrator in the socket, so that the rectified output voltage may be of the correct polarity for either polarity of the storage battery in the car.*

In the synchronous type of vibrator

which serves as a primary circuit interrupter and a synchronous rectifier for the high-voltage output, the polarity of the primary determines the polarity of the output voltage produced. In a tube rectifier, the tube can make use of current flowing in only one direction, thus insuring the correct output polarity. However, the synchronous rectifier is essentially a 2-way circuit, depending entirely on timing of the contacts. Thus, it can produce an output of either polarity.

To compensate for the fact that in some automobiles the negative of the storage battery is grounded, while in others the positive is grounded, the primary or secondary of the power transformer must be reversed for one of the connections. In Fig. 1B the vibrator socket is noted to be a symmetrical 6-hole socket, while the vibrator is a plug of the same pin arrangement, but using only 4 pins. Both socket and plug are marked with polarity for either installation.

Note in Fig. 1B that when the vibrator is removed, turned 180 degrees and replaced, the primary connections are unchanged while the secondary terminals are reversed.

(3) ALL FILAMENTS INCLUDING RECTIFIER SUPPLIED FROM ONE TRANSFORMER WINDING

Philco Models 39-30 and 39-35. *Simplification of wiring and of construction of the power transformer is achieved by making a single power transformer winding serve for all heaters in the set.*

The circuit is shown in Fig. 1C. It is a simple matter, of course, to make a winding which will supply current to all heaters, as tubes can be found for practically every use having the same voltage specifications. Heretofore because of possible leakage from heater to cathode, it has not been thought possible to operate a heater and a cathode of the same tube at a high potential difference. As evidenced by this circuit, it has been shown practical to do this with a type 84 tube. Of course, cathode-to-heater leakage is not so serious in a rectifier as in a signal-carrying tube, as the conditions of high resistance and impedance are not present or required. Moreover the rectifier is the only tube in the group which must operate at this high cathode-to-heater voltage difference.

(Continued on page 431)

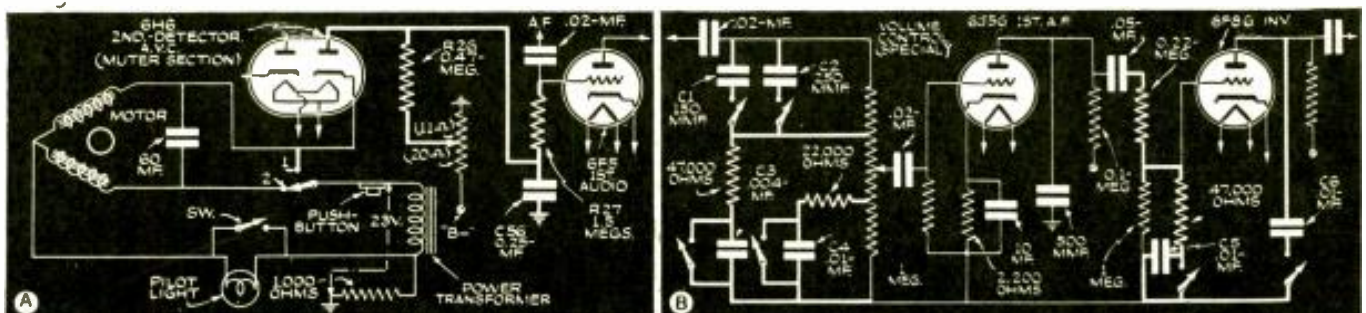

Fig. 2. General Electric and Zenith ("Radiorgan") circuit features. The heavy lines emphasize circuit elements.

THE *Skin-Effect* TALKING LIGHTBEAM

The University of Southern California has cooperated in making available to RADIO-CRAFT readers this first detailed description of the principle and equipment comprising the "skin-effect" light-beam telephone discovery of a U. of S. C. graduate. Anyone can easily duplicate Mr. Mosteller's experiment.

**FOR THE
FIRST
TIME
IN ANY
RADIO
PUBLICATION**

**GERALD
MOSTELLER**



Gerald Mosteller, University of Southern California graduate, is shown with a portion of his apparatus for sending sound over a lightbeam, using an ordinary 5-cent flashlight bulb and simplified radio parts. His discovery formed the thesis for his Master's degree at the University.

A NEW MEANS of transmitting sound over a beam of light by use of amplifiers and an ordinary 5-cent flashlight bulb constituted the writer's thesis, for his Master's degree at the University of Southern California last June.

This simplified form of sending music, voice and other sounds over a lightbeam, discovered during studies in Physics, has been the subject of experiments by scientific laboratories over the country with expensive equipment for a period of years.

Its use in secret communication by the army and navy, landing of airplanes with lights that penetrate fog, and adaptability by automobile races in communicating with their pits, are given among possibilities.

In contrast to radio communications, messages cannot be intercepted except by instruments set up directly in the beam of light. By using infra-red filters an invisible beam can be created which further prevents interception.

HOW IT WORKS

By means of a radio-frequency oscillator and equipment similar to that of the ordinary home radio set, sound is amplified and the output caused to modulate the oscillator.

A "skin effect" is created on the sur-
(Continued on page 446)

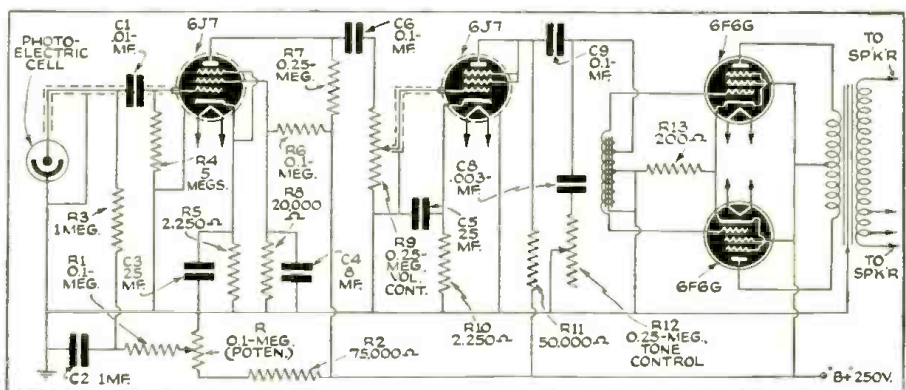

The receiver consists of a photoelectric cell "detector" followed by 3 stages of A.F. amplification. Condenser C1 and resistors R3 and R4 are mounted directly behind the P.E. cell in the reflector.

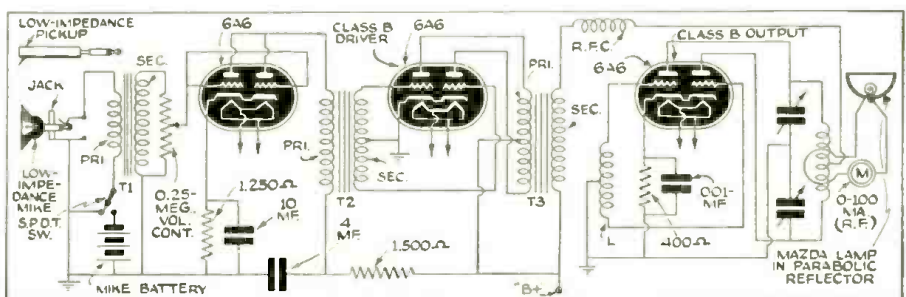

The transmitter consists of a speech amplifier, oscillator and ordinary flashlight bulb. The A.F.-modulated current flows along the surface of the filament (skin-effect) causing rapid fluctuations of the light intensity (which, in turn, are translated into intelligibility by the receiver).

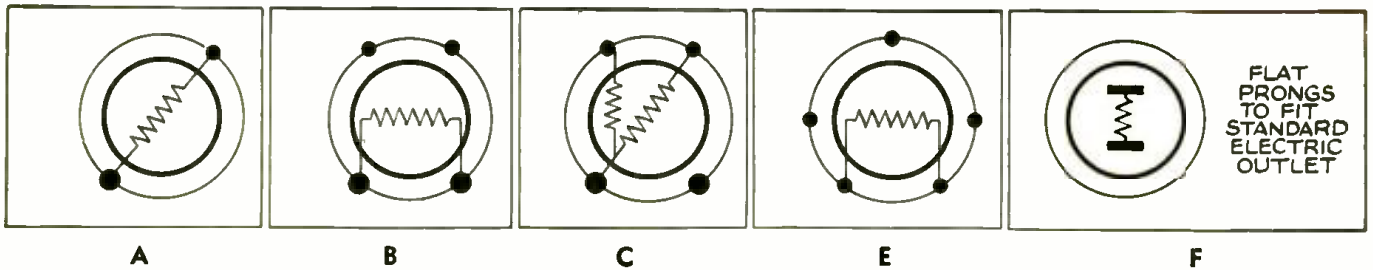

All About BALLAST

In general, RADIO-CRAFT tries to avoid publishing material generally available in many Servicemen may not have seen the following useful service information in a we hope therefore that those of our readers who may have read part of this data in this article which is printed here for



Fig. A. The type 1A1 Current Regulator type of glass-envelope ballast tube is for use in operating 2-V. tubes from a 3-V. "A" supply. The type 185R8 Line Ballast tube replaces the resistor cord in A.C.-D.C. sets; it is also provided with a tap for two 6-8 V. pilot lights.

FROM the number of inquiries which have been received recently, it is evident that there is considerable uncertainty among members of the radio industry regarding the function, purpose, and application of ballast tubes.

As applied to radio, a ballast tube is intended as a regulator to reduce or smooth out variations in voltage or current applied to the set caused by variations in the power supply, either power lines or batteries.

The term "ballast" is a general term which has been applied to all types of regulating tubes. The present popular types of ballast tubes should really be divided into 3 groups according to the type of service for which they are designed.

(1) CURRENT REGULATORS

These are designed to maintain the current to the set (usually filament current) constant when the voltage of the filament supply battery varies during its life.

In battery-operated sets using 2-volt tubes the filaments of all of the tubes are wired in parallel and connected to the filament supply battery. For satisfactory operation of the set and satisfactory tube life the filament current to the tubes must be maintained fairly close to its rated value. During the life of the filament battery its terminal voltage gradually decreases, which means that the current delivered to the tubes in the set also decreases. Many of these sets use 2 drycells in series for a filament supply. When new these have a terminal voltage of about 3.3 volts so that obviously some resistance must be inserted into the set filament circuit so that the tubes will not get more than the

rated 2.0 volts. An ordinary resistor would take care of this but as the drycells dropped in voltage during life, the voltage applied to the tubes would become lower and lower, affecting both the performance of the set and the life of the tubes.

The current regulator tube is intended to replace this resistor and in addition to reducing the battery voltage to the proper value, it has the additional property of automatically changing its resistance so that, in spite of variations in the terminal voltage of the battery, the current supplied to the tubes is held constant.

Since the filaments of the tubes in battery sets are all wired in parallel each different combination of tubes requires a different regulator tube. For example, a set using 1-6C6, 2-34's, 1-32, 1-30, and 1-19 would have a total filament current of 0.620-ampere and would use a type 1J1 current regulator (see Table).

To determine the proper current regulator for any set, it is simply necessary to determine the total filament current and use the regulator tube having this rating. The total set current can be determined by noting the number and type of tubes in the set and determining their respective filament currents from published characteristics such as found in the "National Union Handbook."

(2) VOLTAGE REGULATORS

These are designed to maintain the voltage to the set (usually plate and/or screen) constant when the current drawn by the set varies. Tubes of this type are not usually encountered in ordinary broadcast receivers.

The voltage regulator has the property of automatically varying the amount of current which it draws so that the voltage across its terminals remains constant. If one of these regulators is connected as part of the voltage divider across a power supply, the voltage across the regulator will remain constant regardless of variations in current through the divider or voltage variations from the power supply.

The operation of a voltage regulator may be explained by a simple analogy. Suppose we build a dam across a river. Let the water coming down the river represent our power supply voltage, the dam represent our voltage regulator, and the level of the water above the dam the voltage supplied to the set. No matter how much water comes down the river, the level above the dam will remain approximately constant because all the surplus spills over the dam.

(3) LINE BALLASTS OR RESISTORS

These are designed for use as line dropping resistors in A.C.-D.C. sets and are normally connected in series with the filaments of the tubes in the set.

In this type of set all of the tube filaments are wired in series. Since the total filament voltage required is normally much less than 110 volts, a resistor or regulator must be connected in series with the filaments to make up the additional voltage drop.

The purpose and function of the line ballast are similar to the action of the current regulator

described previously. The ballast tube automatically varies its resistance so that the filament voltage and current are maintained at proper values in spite of variation in line voltage.

Several of the so-called ballast tubes are nothing but resistors and have little or no regulating action. In purchasing be sure to secure true regulators and not just resistors mounted in a metal tube can.

The proper size or type of ballast to use is determined by the filament current drain and the number of tubes in the set. Some of these types are supplied with taps for lighting one or two pilot lights.

There is another type of ballast regulator for A.C. sets. This type is connected in series with the primary of the power transformer, and is intended to keep the transformer voltage constant regardless of variations in line voltage.

In Table I (at end of article) are listed all the glass-envelope tube types shown in Table II and referred-to in basing illustrations A to I (incl.) at the top of this and the facing page.

METAL BALLASTRONS

In addition to the previously-described group of glass-envelope ballast and resistor "tubes" there is also a group of metal-envelope resistance units which the Serviceman frequently encounters. One type in this group is National Union Co.'s type known as the Ballastron; it is available in 2 models, designated A and B. (See Fig. B.)

These 2 Ballastrons serve as replacements for over 100 R.M.A.-coded ballast tubes and many special radio manufacturers' types.

On the base of the Ballastron is an ingeniously-arranged metal strip (see Fig. 1A) which short-circuits 3 sections of the resistance unit inside the metal envelope. By snipping or filing this metal shunt all the way through at one or more of the 3 locations, between prongs 3 and 6, indicated by dots of colored paint, the short-circuit between any 2 prongs is thus removed and the respective resistance section cut into circuit.

A second ingenious arrangement is found in base prongs 2 and 8 which may be unscrewed and removed if they are not required. Here is where the difference exists between the type numbers (A and B) of these metal-envelope ballasts; removable terminals 2 and 8 tap onto the internal resistance unit (see Fig. 1B) to provide ballast operation of a pilot light as described in the caption of Fig. 1.

Terminal 1 is the connection ordinarily used on metal tubes to ground the shell. The resistance element of the Ballastrons, which is made by winding helical-wound resistance wire lengthwise on a mica strip as shown in Fig. B, is tapped-off to terminals 2 to 8 as shown in Fig. 1B. The drops across the various taps of this voltage divider are shown here for the first time in any radio magazine. The drop across the pilot light section of the divider is the same for either current rating (that is, for either the A or B type ballast "tube").

Ballastrons may be "matched" to the require-

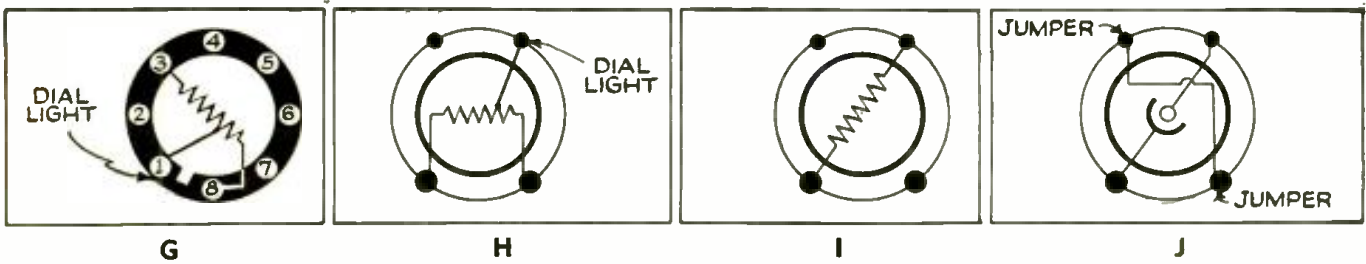

and RESISTOR "TUBES"

widely-circulated literature, as for instance tube manuals. We believe however that recent piece of printed matter put out by a well-known tube manufacturer; and its original form will be partly compensated by the additional service material in the first time in any radio publication.

ments of ballast resistors, carrying R.M.A.-code numbers, in accordance with the directions in the chart, Table III. Also, they may be adjusted to suit the characteristics embodied in various factory-coded units, some of which are listed in Table IV.

NOTE:—If a ballast tube has a first letter "B", disregard it (Example: Ballast tube No. BK-55-D is K-55-D on chart). If the first letter is "M," substitute "K" for it (Example: Ballast tube No. M-55-D is K-55-D on chart). To replace an I-C tube, follow directions for a K-C tube but change pilot lamps to 150 ma. (Type No. 40, brown bead.)

Type No.	Current Rating	Voltage Drop	+Normal Use	Exchange with
1-A-5	0.1	5-25	b	
1B1	0.360	0.3-1.2	a	3H-1
1B2	(0.260)	(0.360)	a	31
1C1	0.750	0.3-1.2	a	7H-1
1C2	(0.120)	(0.250)	a	52
1D1	0.250	0.3-1.2	a	2H-1
1E1	0.4*0	0.3-1.2	a	
1F1	0.720	0.3-1.2	a	7-1
1G1	0.420	0.3-1.2	a	4-1
1J1	0.620	0.3-1.2	a	6-1
LH-1	0.190	0.3-1.2	a	
GM-1				
2	0.30	9.0	g	
2-A-5	0.20	5-25	b	
2H-1	0.240	0.3-1.2	a	1D1
2H-5	0.250	5-25	b	
3	0.30	128	d	
3-1	0.300	0.3-1.2	a	
3-40	0.30	45-80	c	300*, 50X3*, 5B*
3-150	0.30	30-60	e	
3-220	0.30	130-170	d	
3-A-5	0.30	5-25	b	
3H-1	0.360	0.3-1.2	a	1B1
3H-220	0.35	70-130	f	
4	0.40	115	d	
4-1	0.420	0.3-1.2	a	1G1
4-220	0.40	70-130	f	
4-A-5	0.40	5-25	b	
4H-5	0.45	5-25	b	
4H-220	0.45	70-130	f	
5	0.46	115	d	
5-1	0.500	0.3-1.2	a	1A1, 5E1, 6AA
5-16	0.500	0.3-1.2	g	
5-150	0.50	30-60	e	
5-220	0.50	70-130	f	
5-A-5	0.50	5-25	b	
5F1	0.500	0.3-1.2	a	1A1, 5-1, 6AA
5H-1	0.550	0.3-1.2	a	10AB, 1K1
5H-5	0.55	5-25	b	
5H-200	0.55	70-130	f	
6	0.695	0.3-1.2	a	
6-1	0.620	0.3-1.2	a	
6-20	0.60	20-40	h3	
6AA	0.500	0.3-1.2	a	1A1, 5-1, 5E1
6-A-5	0.60	5-25	b	
6H-1	0.660	0.3-1.2	a	
D6-1	0.060	0.3-1.2	a	
7	0.30	176	d	
7-1	0.720	0.3-1.2	a	1F1
7-20	0.70	20-40	h3	
7-150	0.70	30-60	e	
7-A-5	0.70	5-25	b	
7H-1	0.760	0.3-1.2	a	1C1
8	0.30	132	d	
8-A-5	0.80	5-25	b	
9	0.30	90	c	
9-20	0.90	20-40	h3	93, 100, 105, 106
9-150	0.90	30-60	e	
9-A-5	0.90	5-25	b	
9V10	0.80	5-25	b	
10-10	1.00	10-30	h2	125
10AB	0.550	0.3-1.2	a	5H-1
10-A-5	1.00	5-25	b	
10V10	1.00	10-20	h1	
11-10	1.10	10-30	h2	118-415

TABLE II

Type No.	Current Rating	Voltage Drop	+Normal Use	Exchange with
1-1	0.120	0.3-1.2	a	
1A1	0.500	0.3-1.2	a	5-1, 5E1, 6AA
1A2	(0.120)	(0.320)	a	30

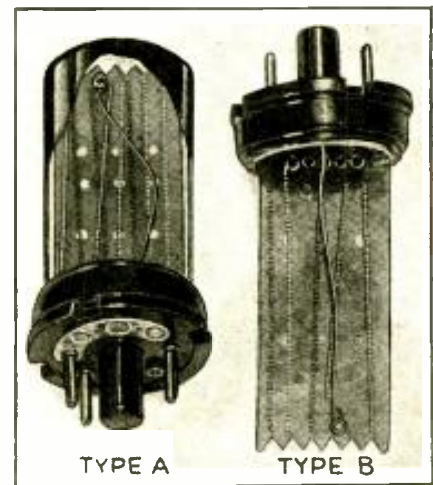

Fig. 8. These metal-envelope Ballastrons are ingeniously designed to replace over 100 R.M.A.-coded ballasts. The basing arrangement and (for the first time in any radio magazine) voltage divider design are shown in Fig. 1.

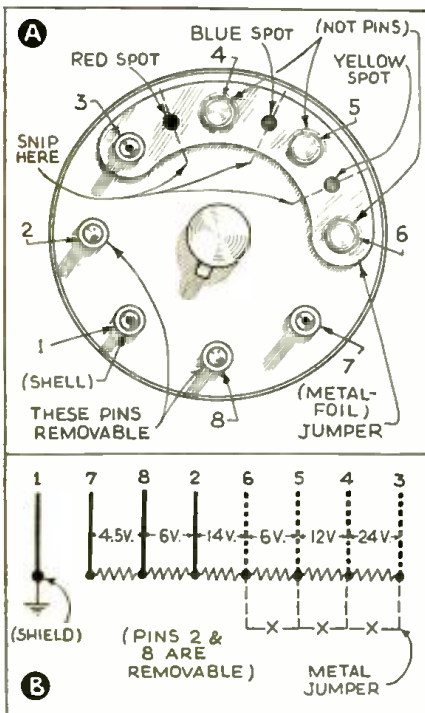

Fig. 1. The types A and B Ballastrons (metal ballast tubes) vary only in the rating of the resistance section between removable terminals 2 and 8. The type A is designed for a pilot light rated at 150 ma.; the type B is for a 250 ma. pilot light. The metal jumper may be snipped along the dotted lines that bisect the color-code dots, as shown at A, to unshort resistor sections inside the tube as shown at B (where X represents the snipping lines shown dotted in A).

Type No.	Current Rating	Voltage Drop	+Normal Use	Exchange with
11-20	1.10	20-40	h3	110
11-150	1.10	30-60	e	038
11-A-5	1.10	5-25	b	
12-20	1.20	20-40	h3	126
13-10	1.30	10-20	h2	130
13-20	1.30	20-40	h3	313
13-A-5	1.30	5-25	b	
14-20	1.40	20-40	h3	314
14-A-5	1.40	5-25	b	
15-10	1.50	10-30	h2	150
15-20	1.50	20-40	h3	315
18-10	1.80	10-20	h1	
20-A-5	2.00	5-25	b	
22-10	2.20	10-30	h2	
30	(0.120)			
31	(0.320)	0.3-1.2	a	1A2
	(0.260)			
	(0.360)	0.3-1.2	a	1B2
038	1.10	38		11-150
42A1	0.30	42.3	m	
42A2	0.30	42.3	m-1	
42B2	0.30	42.3	m-2	
46A1	0.40	30-60	k	
46B1	0.30	30-60	k	
49A1	0.30	48.6	m	
49A2	0.30	48.6	m-1	
49B2	0.30	48.6	m-2	
52	(0.120)			
	(0.250)	0.3-1.2	a	1C2
55A1	0.30	54.9	m	
55A2	0.30	54.9	m-1	
55B2	0.30	54.9	m-2	
70	0.90	30-60	k1	
99	1.40	30-60	k1	

(Continued on page 442)

THE LATEST RADIO EQUIPMENT

The address of any mentioned manufacturer will be sent on receipt of a self-addressed, stamped envelope. Mention of item number hastens reply.

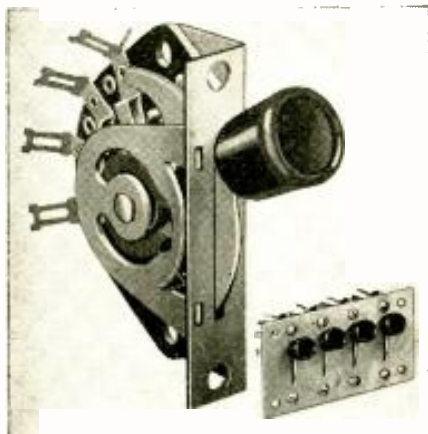

New low-capacity lever-action switch. (1706)

LOW-CAPACITY LEVER-ACTION SWITCH (1706)

(Centralab)

SOMETHING entirely new in the line of selector switches! These units find a wide range of applications in the broadcasting, receiving, amateur radio, public address and industrial signaling fields. As shown in the illustration the switches are available singly or in ganged form by means of a mounting plate furnished by the company. Each switch will take up to 12 contacts and can be used in countless shorting and non-shorting sequences. Contacts are of the sure double-wipe type. These switches are furnished with either 2 or 3 positions; index action can be positive in all positions, or spring-return to center from either side.

The tester is available with a plug-in set analyzer as illustrated.

AUTOMOBILE FILTER UNITS (1709)

(Cornell-Dubilier Electric Corp.)

A NEW complete line of automobile filter units is now available for all the various condenser requirements in auto-radio service work. The units are constructed to withstand excessive temperatures and motor vibrations. Many of them are designed for specific applications such as for Ford generators with special mounting brackets, etc. Mechanically, these condensers are identical to those supplied by the larger auto-set manufacturers. The vibrator condensers are oil-treated to withstand high peak and surge voltages up to 3,000 V.

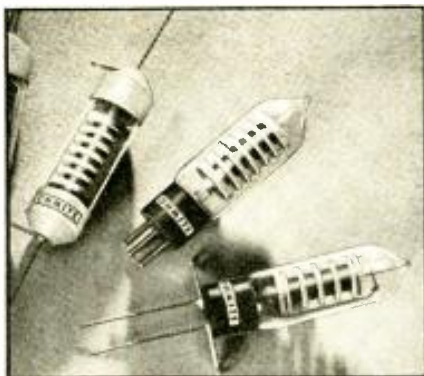

Hermetically-sealed precision resistors. (1707)

HERMETICALLY-SEALED PRECISION RESISTORS (1707)

(Ohmite Manufacturing Co.)

THIS first commercial series of hermetically-glass-sealed precision resistors provides the fullest protection against extreme heat, humidity, salt air, sulphur fumes and other severe atmospheric conditions in industrial, coastal, marine and tropical locations. Radio equipment using these resistors can be operated in any clime with the assurance that the resistors will not go "sour." The units are non-inductively pie-wound, on porcelain, in 2, 4, 6, or 8 sections. Resistances range from 0.1-ohm to 2 megohms. Swell for wherever a highly precise resistor is required.

SILENT MERCURY-BREAK TOGGLE SWITCHES (1710)

(General Electric Co.)

APPROXIMATELY 15,000,000 house switches, purchased in the United States every year, audibly "click" away their lives; moving parts and springs wearing out and contacts burning off. The introduction of this new line of silent mercury-contact type switches not only eliminates the audible click, which for many years has been the symbol of light control, but provides a lifetime unit. Actual contact is made and broken by the movement of a small amount of mercury in a gas-filled metal-glass sealed element the size of a small coat-button. The switch casing and handle are of Textolite. Large binding-screw heads readily accommodate No. 12 wire. The switch can be installed in any standard switch box but must be mounted vertically. Radio men, to be up-to-date, may want to use these switches in new equipment.



Latest combination tube and set tester. (1708)

COMBINATION TUBE AND SET TESTER (1708)

(Radio City Products Co., Inc.)

IN ADDITION to testing all types of tubes this popular-priced tube and set tester contains the following meter ranges: 4 D.C. and A.C. voltmeter ranges from 0 to 1,000; 4 D.C. milliammeter ranges from 0 to 1,000; 4 ohmmeter ranges up to 10 megohms; 1 D.C. ammeter range 0 to 10; and 1 decibel range from -8 to +55 db. Provisions are also made for reading condenser leakage. The meter for tube testing has a clear-reading scale 4½ ins. square and provides an accuracy of 2 per cent. A unique method (superior to that of a copper-oxide rectifier) of obtaining A.C. voltage measurements assures a linear scale. This is said to eliminate frequency, waveform and temperature errors within all practical limits.

TINY "MINICAP" CONDENSERS (1711)

(Solar Mfg. Corp.)

THE UTILITY of the small Minicap dry electrolytic condenser (mentioned last month in the Radio Trade Digest department) has been extended to practically all commonly-used values. The manufacturer claims that the Minicap units occupy less space and have longer life (through permanent sealing) than other units of similar electrical specifications.

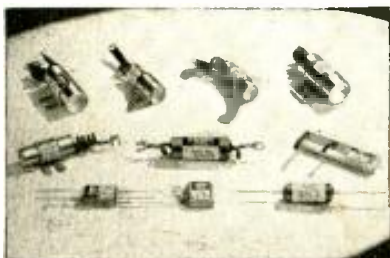

New line of automobile filter units. (1709)



Silent mercury-break toggle switch. (1710)



New dual "Minicap" condensers. (1711)

SERVICING QUESTIONS & ANSWERS

Servicemen may write, requesting answers to specific service questions. Address inquiries to Service Editor. For questions answered by mail, a service fee of 25c per question is made. Only questions of wide interest can be published.

CUTS OFF AFTER 5 MINUTES

(100) Warren Preeshl, New Richmond, Wis.

(Q.) I have a set in my shop that has me stymied. It is a Sentinel model 118, serial No. 69663. This set is made by United Air Cleaner Corp., and has the following tube line-up: 2-24A's, 3-27's, 2-35/51's, 2-47's, 1-80—ten tubes in all. Set cuts off after being run for about 5 minutes. I have tested tubes and replaced all bad ones. When a 47 or a certain 27 is pulled out the set keeps on playing. What would be the best way to try to find that trouble? Is it a common fault with this radio? The set seems to have phase inversion to drive the 47's. It seems that there is something wrong with the audio section although an audio signal comes through OK.

(A.) Inoperation of a model 118 Sentinel receiver after several minutes of reception has often been found due to intermittent audio coupling condensers. We suggest that a 0.05-mf. condenser be employed to locate the faulty unit by shunting each coupling condenser in the receiver, after reception has cut off. The coupling condenser most frequently replaced is that connected to the "high" side of the volume control.

80-TYPE TUBE BLOWS CONSISTENTLY

(101) D. A. Coyle, Oakland, Calif.

(Q.) A customer up in the mountains has written advising that he will have an RCA 140 8-tube super. brought down to my shop in the near future for repairs.

Trouble is burning out of the 80-type tube. Has been worked on by a local Serviceman without remedying the trouble. Tube will burn out in about 2 minutes after turning on switch, plates on the 80 first becoming red hot. Customer sent down several of the 80's, all with the same side of the filament burned out.

I'm getting worried about this set, as the customer will be in town only a few hours and I thought perhaps this set might have some "bugs" which would localize the trouble and save me time. Have you heard of any? If not, to refresh my memory will you jot down a list of possible causes so I can check them in order.

I understand that the set plays perfectly for the 2 minutes prior to the 80 burning out.

(A.) It is evident from your letter that a short-circuit or at least a low-resistance leakage exists in the high-voltage power supply circuit of the RCA type 140 receiver; it is almost certain that there is no fault in the 80-filament voltage supply winding.

Check all filter condensers in the power supply and last audio sections for leakage. It is possible that the 18-mf. electrolytic unit connected to one side of choke L37 is drawing so much current it shoots the 80—with enough current left over however to afford fair radio reproduction until the tube blows.

Also, check the primary of the output transformer, each side of which should measure 335 ohms. A short across one-half the primary would afford temporary single-ended action instead of the requisite push-pull reception.

Open the "B—" circuit right at the 80 and check for normal current drain. If an abnormal reading is obtained check from that point to determine the source of the low-resistance shunt causing the abnormally high current drain.

AMPLIFIER HUM LEVEL

(102) D. E. Wills, Hagerstown, Md.

(Q.) I am interested in knowing if the hum level in the amplifier described below is audible in the speaker with the crystal mike connected and gain full-open or when the 1st stage is shorted from grid to ground.

The characteristics of the amplifier are as follows: power output, 10 watts or plus 32.2 db. (2% distortion); gain with high-impedance input, 110 db.; hum, 63 db. below maximum output; frequency response plus or minus 1½ db. from 20 to 15,000 cycles. Tubes: 3-6C6's, 2-76's, 2-2A3's, 1-5Z3, 1-80.

Would an amplifier having the same output and hum level, and rated at 1.6 milliwatts, be the same in hum level?

(A.) Hum measurements on audio amplifiers are usually made with gain controls turned full-on and input terminals shorted. The hum level, of an amplifier of rated 32.2 db. output which is down 63 db. below full output, is considered very low and probably will not be audible.

An amplifier with a power output of 32.2 db. and a hum level of 1.6 milliwatts has a higher hum level than the one mentioned above.

VERY NOISY—BLASTS

(103) Victor Solorzano, San Francisco, Calif.

(Q.) I have a Majestic receiver, model 220, which I have been trying to repair for almost 2 weeks. It is very noisy and at times blasts terribly, especially between stations. As far as I know, the trouble lies in the R.F. end, as when I put a voltmeter across the cathode biasing resistor for the type 35 R.F. tube, the needle fluctuates continuously along a ¼ portion of the meter scale. I have checked all the bypass condensers and all test OK. I have changed all the decoupling condensers on all the grid-returns or A.V.C. circuits, and all resistors on these same circuits check OK. Everything on the 2nd-detector stage and A.F. end as well as the power pack check OK. I tried increasing the value of the above-mentioned biasing resistor, but it didn't help any. All voltages check all right, as well as all tubes. The noise disappears a little when a strong station is tuned in.

What would you suggest?

(A.) Noisy reception on the Majestic model 270 receiver, such as described in your letter, has been traced to defective R.F. and I.F. transformers in which the

primary windings increase and vary in D.C. resistance.

This may be checked by connecting a sensitive voltmeter across each suspected primary winding. Use the lowest possible voltage range and short meter leads. Any discernible fluctuation across any R.F. or I.F. winding during reception will point to the trouble.

OSCILLATION IN RADIOLA 18

(104) Linwood Hunter, Wildwood, N. J.

(Q.) I have a couple of old early electric sets in my shop in which, for my own information, I would like to find the trouble. They use types 226, 227 and 71 tubes.

One, for example, is a Radiola 18. This set went practically dead. I replaced the R.F. tubes which were bad, with new type 226's. Now with the volume control past the halfway position the set (circuit) oscillates and reception can only be heard faintly with the signal input low (volume control in antenna circuit turned down below half).

I've checked all condensers and resistors but fail to find the trouble.

Tubes that are weak work better in the set but don't give enough output. I would appreciate any information you may give me concerning these old sets.

(A.) On the Radiola 18, an "oscillation control" may be adjusted to overcome the condition described in your letter.

This oscillation control is a semi-fixed condenser, whose adjustment screw is accessible through a hole in the "bathtub" of the condenser gang. A small strip of brown paper may cover this hole.

With new tubes installed and the receiver tuned to some station at or about 1,000 kc., tighten the condenser screw clockwise. Then, slowly turn the adjustment screw counter-clockwise just past the point of oscillation.

ERRATIC OSCILLATOR STAGE

(105) D. H. Velander, Los Angeles, Calif.

(Q.) We have had a Majestic model 20 in the shop for about 6 weeks now and have been unable to cure the trouble. It quits oscillating on the lower half of the band. Sometimes it will start on 640 kc. and play perfectly for from 1 to 3 or 4 hours and then stop; sometimes it won't start at all below 1,000 kc. We have replaced all pigtail condensers, resistors and finally the oscillator coil but to no avail.

Having the voltmeter on the screen-grid supply (which also furnishes plate voltage to the oscillator), the voltages drop from 10-25 V. when the set goes dead. However by dropping the voltage at the divider it will not cause the set (circuit) to stop oscillating, but by shorting the oscillator tuning condenser (stator) to ground the same drop in voltage occurs.

I have had 3 or 4 other Servicemen work on it and they had the same kick as I have. Have tried all new tubes and several oscillator tubes but they seem to make no dif-

(Continued on page 441)

OPERATING NOTES

ANALYSES of RADIO RECEIVER SYMPTOMS

SERVICEMEN—What faults have you encountered in late-model radio sets? Note that RADIO-CRAFT will consider your Operating Notes provided they relate to characteristic (repeatedly encountered) faults of a given set model. Payment is made after publication of the Operating Note.

Trouble in . . .

. . . ZENITH MODEL 4V-31 (Chassis 5405)
Within the past 4 months I have had 3 Zenith radio sets, model 4V-31, chassis 5405, in for service due to being "dead" on the lower-half of the dial, that is, from about 890 kc., on down.

I found the trouble to be due to the oscillator not oscillating. Everything checked OK, but I substituted new oscillator tubes, new oscillator padder, transformer, resistors, etc., but still with no results.

The oscillator transformer is mounted underneath the chassis and is not shielded. So I tried shielding the oscillator and after doing so it would work fine on the lower end of the dial and up to about 1,300 kc., but was dead from there on up. So I removed the shield from the transformer and loosened the 2 stud mounting bolts that hold the transformer to the chassis and pulled the transformer away from the chassis at various distances. I then found that by raising the transformer about 1/4-inch from the chassis the set would work fine over the complete dial. So I cut 2 little pieces of insulating tubing about 1/4-inch long and installed them between the transformer and the chassis. Before raising the transformer you could screw the oscillator padder to the right as far as it would go and you could get it to oscillate down to about 810 kc., this being the reason I installed a new padder even though the old one checked OK.

The last 2 I got in for service with the same complaint and after checking tubes and finding them OK, I immediately raised the oscillator coil as in the first one and they both worked perfectly without even having to readjust the trimmers.

FRED E. BERRY,
Berry's Radio Service

. . . GENERAL ELECTRIC COLOR TUNING

A puzzling situation is present, in the instance of the color tuning in this make of set failing to operate, due to the fact that the circuit of the 6K7 color tuning tube will check OK with either a voltage

or continuity test. The trouble lies in open windings in the reactor transformer in the plate circuit of the 6K7. These windings are shunted by resistors which make the circuit check OK. See Fig. 1 for location.

R. E. Green Radio Service

. . . STROMBERG-CARLSON 345 SERIES

We have received a few requests for more bass response on the model 345 receivers. This can be accomplished by making the very simple change which is outlined below. This change is incorporated in all receivers manufactured after Sept. 1, 1938.

Remove the 4,700-ohm resistor (R17) from the volume control tap and replace with a 10,000-ohm resistor (Pc. 26345).

Remove the 0.15-mf. condenser (C37)

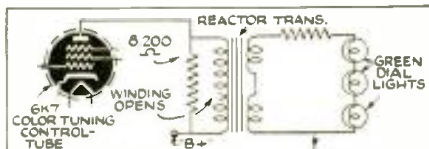

Fig. 1. G.E. color-tuning reactor goes bad.

from the volume control tap and replace with a 0.1-mf. condenser (Pc. 24402).

Remove the 0.001-mf. condenser (C42) from the "high" side of the volume control and replace with a 0.04-mf. condenser (Pc. 24405).

Caution: Do not mistake condenser C38 for one of the condensers to be changed. STROMBERG-CARLSON SOLDER NUGGETS

. . . MAJESTIC MODEL 15

Open primary or secondary windings of either the 1st or 2nd I.F. transformer is the most common trouble in these receivers. If called upon to service this receiver and

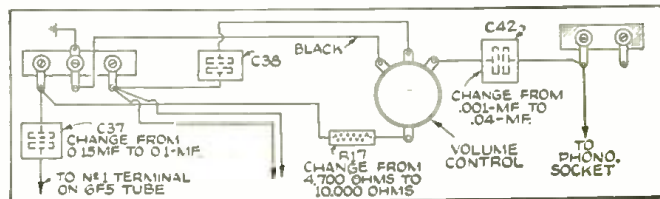

Fig. 2. Increasing bass response in Stromberg-Carlson 345 Series receivers.

one of the I.F. transformers is open, the best procedure is to replace both transformers. Otherwise the set will probably be brought back in a couple of weeks with the other transformer open. This has happened on 3 occasions. Coils for these receivers can be bought separately and placed in the original shield cans at a much greater saving in cost.

And for the few additional cents that the other coil would cost it is not worth risking losing the customer.

These coils are not interchangeable. The first I.F. transformer has 3 windings, while the second has only 2. Therefore when ordering the coils they must be specified.

RUSSELL HILBERT

. . . MIDWEST 16-37

For better stability and more gain on weak stations, add a 300-ohm bias resistor to 1st I.F. 6K7 tube, and a 1,000-ohm bias resistor to 2nd I.F. 6K7 tube. Bypass each with a 0.1-mf. condenser. The cathodes are grounded direct on this model. Open and insert bias resistors.

L. J. MEYERS

. . . RCA 85BT AND 86BT

Distortion, overloading, or motorboating in these models is almost always caused by the 7 1/2-volt "C" battery losing 1/4- to 1/2-volt on the first cell at the positive end. This trouble is hard to find because this small drop is hardly noticeable when checking the "C" battery, and it is often caused by the battery-holding clamp rusting, and eating into the battery. Insulate the new "C" unit from this rust with heavy cardboard or paper.

. . . RCA 86T TO 810K

At least one-fourth of these models had the same trouble—a slipping dial belt. This can be repaired by swinging the belt tightener to the other side of the belt and lengthening the spring with a 1/2-inch piece of wire.

. . . MOTOROLA 52T

Weak or noisy reception in this model set is caused by a "high-resistance open" in one of the I.F. transformer primaries;—in a few cases by the same trouble in the oscillator coil primary.

. . . MOTOROLA 10Y

Noisy or weak reception in this model is caused by a "high-resistance open" in either the R.F. or I.F. primary. Increased hum in these models is caused by the

(Continued on page 441)

SERVICING ODDITY

BELIEVE IT OR NOT — COCK ROACHES DID THIS!

INSULATION EATEN AND WINDING BROKEN

Dear Sir:
In all the years I have been reading *Radio-Craft*, I have seen some radio repair oddities appear now and then but hardly any as unique as the enclosed.
The photo is that of the ordinary midget choke in small sets. This particular set was kept in a downtown New York factory which had more than its share of omnivorous pests. In addition to eating the insulation off the choke and breaking the winding, the insects had started on the wire insulation and had even begun housekeeping in one of the I.F. coils! Sounds like a rather tall story I'll admit but is nevertheless true.
I merely send this item on to you to do with as you wish. It is, in fact, a humorous episode injecting a smile or two into the usual headaches of the day.
Yours truly,
DONALD DE CAIN
Any more illustrated SERVICE ODDITIES, follows?—Editor

These 3 GHIRARDI Books are TOPS in RADIO!

GET IT ALL FOR \$4

RADIO PHYSICS COURSE

BY ALFRED A. GHIRARDI

Here's your Education in RADIO FUNDAMENTALS

Complete in 1 big book

EVERY phase of Radio, Electricity, Television, Sound and Cathode-Ray Tubes is made crystal-clear by Alfred A. Ghirardi in this one handy, inexpensive volume. You need no longer be held back from a radio career because you could not spare the time or money to take a training course. This great radio book brings you all you missed—and more. Here in condensed form is the essential radio and electrical knowledge demanded of every radio technician by radio service firms, manufacturers, modern broadcast stations, sound-film studios, etc. No matter what branch of radio you want to enter, Ghirardi's RADIO PHYSICS COURSE will give you a thorough training at minimum cost. You can start at once, with no further thought of the time or expense involved. Even if you can devote only a few minutes a day to your study, you will be amazed at the speed and ease with which you will pick up radio from this amazing book.

Here's what you learn

about:
Sound, Speech and Music . . .
Electricity . . .
Electric Units and Circuits . . .
Resistance . . .
Ohm's Law . . .
Batteries . . .
Magnetism . . .
Electromagnetism . . .
Transformers . . .
Inductance . . .
Capacitors . . .
Alternating Current Circuits . . .
Filters . . .
Electrical Measuring Instruments . . .
Radio Waves and Radiations . . .
Broadcast Stations . . .
Receiving Equipment . . .
Vacuum Tubes . . .
Radio and Audio Frequency Amplification . . .
Superheterodynes . . .
Loud Speakers . . .
Battery Operated Receivers . . .
Power Supply Units . . .
Electric Receivers . . .
Automobile and Aircraft Re-

Learn Radio in your Easy Chair!

Never before has profitable radio study been such a delightful pastime. This remarkable book makes every subject perfectly clear and understandable, regardless of your previous training or experience. No mathematical requirements. Diagrams, charts and photos in great abundance (over 500 of them!) make the most difficult subjects easy to grasp. Review Questions (856 of them!) help you to check on your progress every step of the way and get the most out of home-study. Thousands of successful men in radio have learned from this great book, for the RADIO PHYSICS COURSE is used as the basic text by more radio schools and students than any other radio book in the world. There must be some reason for such universal endorsement. The same advantages are yours for the asking.

10-DAY TRIAL

Send for your copy at once! Our MONEY-BACK GUARANTEE gives you full protection, for you may return the book within 10 days, undamaged, and your money will immediately be refunded. Here's your BIG OPPORTUNITY! Take it! Fill out the coupon below! Mail it! NOW!

TEAR OUT - MAIL NOW!

Receivers . . .
Photograph Pictographs . . .
P. A. Systems . . .
Short-Wave Receivers . . .
Photocells . . .
Television Antennas . . .
and Grounds . . .
Testing and Servicing Receivers . . .
Sound Motion Pictures . . .
Review Questions for Self-Study . . .
AND DOZENS OF OTHER SUBJECTS!

972 pp. 500 illus. \$4

RADIO & TECHNICAL PUBLISHING CO., Dept. RC-19

45 Astor Place, New York
Here is \$4 (\$4.50 foreign) for my copy of RADIO PHYSICS COURSE. Ship postpaid at once with 10-day Money-Back Guarantee.

NAME
ADDRESS
CITY STATE
 Send free descriptive literature

LEARN RADIO THE Easy Way

HOT OFF THE PRESS

Ghirardi's latest

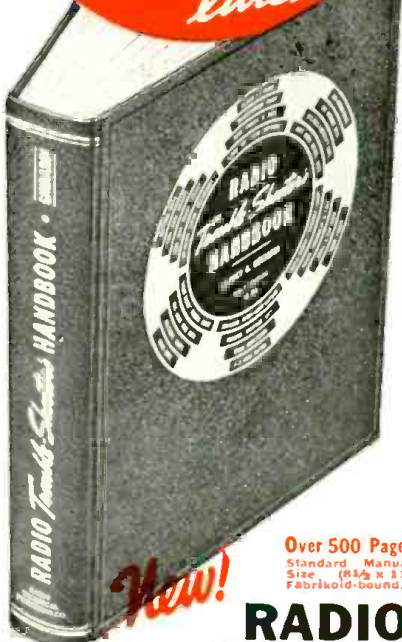

Over 500 Pages
Standard Manual Size (8 1/2 x 11)
Foliot-bound.

RADIO Trouble-Shooter's HANDBOOK

3,313 Case Histories
Trouble symptoms and remedies for 3,313 sets, compiled from actual service records.

I-F Peaks
Over 12,000 listings for alignment of every superhet ever made, old and new, including 1939 models and "orphans."

Auto-Radio
Interference Elimination for over 80 car models. Installation and Car Ignition System Data Chart for all cars. Electrical Wiring Diagrams. Gear Ratios and Dial Directions for Tuning Controls.

Other Data
Trouble-Shooting Charts. Servicing Home Receivers, Intercommunication Systems. Trade Directories. Grid-Bias Resistors. Color Codes, etc., etc.

NEW as tomorrow's radio sets is this latest Ghirardi serviceman's Handbook—a Handbook that has rightly been called "the most practical and useful collection of time-saving, money-making working data ever issued for radio servicemen." Get and use this great 500-page book, with its loads of indispensable factory-checked servicing tabulations and organized for split-second reference. Its Case History section alone will definitely show you how to locate instantly the weaknesses and troubles in 3,313 models of receivers, representing 177 manufacturers. Besides this, there are 274 more pages of practical information of all kinds—and right up to the minute—even for the latest 1939 models! What's more, it doesn't duplicate anything else you now have in your standard service manuals.

TIME IS MONEY

Every hour of trouble-shooting you save means actual dollars and cents in your pocket. That's how Ghirardi saves your money. Here, in a flash, right at your finger tips, is the data to solve quickly even your "toughest" jobs.

Send for it today—TRY IT 10 DAYS AT OUR RISK—test it out in your own shop—compare it. Then, if you feel you can part with it, send it back, in good condition, and we'll refund every penny of your money at once. You take no chances with our ironclad MONEY-BACK GUARANTEE. Don't fall behind. Don't let it slide. ORDER YOUR COPY NOW!

\$3

RADIO & TECHNICAL PUBLISHING CO., Dept. RC-19, 45 Astor Place, New York, N.Y.

- Here is \$3 (\$3.50 foreign) for my copy of TROUBLE-SHOOTER'S HANDBOOK. Ship postpaid at once with 10-day Money-Back Guarantee.
- Here is \$4 (\$4.50 foreign) for my copy of MODERN RADIO SERVICING (see ad at right), with same guarantee.
- Here is \$6.50 (\$7 foreign), the "Special Limited-Time Combination Price" for BOTH BOOKS together.

NAME
ADDRESS
CITY STATE

Please send free literature describing detailed contents of:
 RADIO TROUBLE-SHOOTING HANDBOOK
 MODERN RADIO SERVICING



PUTS A WHOLE

ARMY OF SERVICE MEN to work for You.

CONDENSED in this one big book you'll get a complete course in the principles and actual technique of radio service work, with complete explanations of the operation, construction and use of all the modern test and repair instruments. The experience this book will give you is what a vast army of the country's leading servicemen and servicing organizations have learned about how to do service work in the most efficient, rapid, modern manner. Draw upon this vast reservoir of practical and theoretical information and you will quickly step up your own servicing experience by many thousands of hours! The knowledge you will get here is virtually priceless, considering the time, effort and money it cost to gather. All that work and all that expense you save! You get it complete for just \$4. Just think—one compact, convenient book that will teach you EVERYTHING.

YOU LEARN How It's Done—and Why

Here you'll learn the whole theory and construction of test instruments—how they work—how to use them—how to build them, etc. You'll get a whole book in itself on the practical servicing of receivers—trouble-shooting, analyzing, repairing. And that's just a small part of the whole contents of this amazingly comprehensive source-book, which is written and illustrated in the usual thorough, clear Ghirardi manner—quick and easy to understand. You can put this additional experience to work in your shop tomorrow!

Order the book at once—our MONEY-BACK GUARANTEE protects you!

A. A. Ghirardi's MODERN RADIO SERVICING



1300 PAGES
706 ILLUS.

DO THIS NOW!

Use Coupon at the Left. (Bottom of Middle Column.)

FILL IT OUT and MAIL TODAY!

Here's What Ghirardi Brings You:

TEST EQUIPMENT
A 420-page section, explaining for you the whole theory and construction of every type of test and servicing equipment. Diagrams, construction data, etc., etc.

TROUBLE SHOOTING
254 pages packed full of latest short-cuts in tracking down all kinds of receiver troubles.

REPAIRING
184 pages of valuable time-saving repair methods: superhet alignment; interference elimination; etc., etc.

SPECIAL PROBLEMS
442 pages on Auto-Radio Installation and Servicing; Servicing of All-Wave and High-Fidelity sets; AVC and QAVC circuits; How to Run a Servicing Business, etc., etc.

RADIO HOME-STUDY IDEA

UP TO THE MINUTE AS A STREAMLINER.

New

SPRAYBERRY

Personalized TRAINING in RADIO



HOW TO MAKE MONEY IN RADIO
 ● SPRAYBERRY ACADEMY OF RADIO

Get my **FREE BOOK** FOR AMAZING DETAIL

WITH THIS SENSATIONAL METHOD
YOU CAN LEARN RADIO—QUICKLY
MAKE GOOD PROFITS—SOON

ACTUALLY SET YOU UP FOR YOUR OWN BUSINESS

Here's a brand-new, altogether different type of Radio Education that's specially designed to give you intense, practical, quick training . . . for a money-making career in the fast-moving Radio Industry. Moreover, I back you up all the way with close *personal attention*. This is not an idle promise.

My training starts right at the beginning of Radio . . . unfolds each subject in a simplified, logical, understandable style. You easily learn all about Television, Electronics, Police Radio, Ship Radio, Commercial Radio Broadcasting . . . Radio Set Repair and Installation Work, etc. Every essential subject of Radio is covered. Now, let me show you how I equip you for your own business.

NO PREVIOUS EXPERIENCE NEEDED

It makes no difference what your past experience or education has been—if you are a fellow of average intelligence, I can fit you for an excellent-paying job in Radio. Your success is my full responsibility. I know how to get Radio across to you so that you will understand it—remember it—make good money out of your knowledge. Don't forget—the Sprayberry Method is never tiring or boring. Every phase of Sprayberry study is fascinating, interesting and practical from beginning to end.

QUIT DREAMING! MAKE A FUTURE FOR YOURSELF
 Prepare for a Good Paying Job

No matter if you desire to BE YOUR OWN BOSS in your own business . . . or hold down a good job in Radio, my Training will give you the useful information and knowledge to help win success. It is easy enough to sit idly by and envy those fellows who have good-paying jobs and are building toward splendid incomes and real security in the future. BUT THESE FELLOWS ARE NO SMARTER THAN YOU. The essential difference is that they have taken the initiative to pull themselves up by their own bootstraps. You can do the same thing. Don't just "wish" for more money . . . start training for it—RIGHT NOW.



You get real **PROFESSIONAL EQUIPMENT** to handle money-making spare time jobs

A truly amazing array of fine, high quality Equipment, Radio Parts and Tools is delivered to you as a regular feature of Sprayberry Training. These units will enable you to learn Radio easily and quickly by carrying out actual Radio experiments with your own hands. Secondly, the Equipment I supply will help you get into the money-making side of Radio—soon after you begin your training. Through the valuable spare-time **BUSINESS BUILDERS** I provide you will be shown where to find profitable Radio Service Jobs . . . right in your own neighborhood—and how to do these jobs. You will be able to make practical applications of the theories and principles learned from my experiments and lesson study—money-making use of the Equipment supplied. You get real, honest-to-goodness experience and add to your bank account as the same time.

EXPERIMENTAL OUTFITS GIVEN

These will enable you to carry out additional interesting experiments that will further make the theory of Radio crystal clear to you. Don't forget . . . what you learn by working with your own hands, you always remember

YOU RECEIVE PERSONAL COACHING SERVICE ALL THE WAY.

THESE SPRAYBERRY GRADUATES ARE ENJOYING RAPID ADVANCEMENT WITH BIG FUTURE AHEAD

Deluged with Work



Edwin A. Gammon, Auburn, Me., writes: "Your Course is so thoroughly good and practical that it is hard to pick out one part that is better than any other. Due to the knowledge I have gotten from it, I have been deluged with work for the last month, achieving good results with Radios which had been unsatisfactorily tackled by other servicemen. You deserve all the credit."

"Cleared" \$150 in Spare Time



A. H. Lanole, Northbridge, Mass., writes: "Since enrolling I have cleared a net profit of more than \$150 in spare time alone . . . and I am not one-half through the course yet. Honestly, I cannot understand how you can give so much 'dope' for so little money."

RUSH THIS COUPON for BIG FREE Book

SERVICEMEN!

I offer special Advanced Training for those already in Radio. I'll show you the newest methods . . . newest circuits and short-cuts. I'll show you how to do the jobs other Radio men can't handle . . . how to really cash in on your ability. Complete details of this Advanced Course and Fundamental Course, Features, etc., fully described in my new 52-page **FREE BOOK**.

REMEMBER—THE SPRAYBERRY COURSE IS SOLD UNDER AN IRON-CLAD, MONEY-BACK AGREEMENT

DON'T DELAY!

SPRAYBERRY ACADEMY OF RADIO
 F. L. Sprayberry, Pres.
 120-N University Place, N. W. **Act Now**
 Washington, D. C.

Please send me **FREE** copy of "HOW TO MAKE MONEY IN RADIO."

NAME AGE

ADDRESS

CITY STATE

Tear off this coupon, mail in envelope or paste on penny postcard. (Servicemen—Check Here)

Exactly what you need for **QUICK ADVANCEMENT in RADIO**

All the worthwhile
Radio Trade News
of the past Month—
Digested for busy
radio men.

RADIO Trade Digest

A PLEDGE: — To
print the important
news of the radio
industry; to review
major news events;
to help point a path
to radio profits.

IMPORTANT HAPPENINGS OF THE MONTH IN THE RADIO INDUSTRY

No. 5

JANUARY, 1939

No. 5

DILATORY U.S. MANUFACTURERS MAY LOSE TELEVISION MARKET

*As Mrs. Here Are Caught W.P.D., Britain's "Scophony"
System Arranges \$10,000,000 American Set-Up
With Cantor as Probable Head*

When RCA's David Sarnoff announced plans to break television in the Spring, RTD sent 30 leading American radio mfrs. the following wire:—"Do you plan to produce Television sets in near future? If so, when will production be commenced? Please rush available details of plans."

Replies were received from 18—and only 4 of these stated that definite plans for production of television receivers were being made. To these must be added RCA, which, while it did not reply, is doubtless going to take a leading place in television mfg.

Meanwhile, *Radio Daily* revealed that the managing director of Scophony, leading British telly mfr., is in N.Y. with plans to start a \$10,000,000 branch of the parent co., to produce sets here and market them at about \$200. If Scophony starts first, it may well get an unbeatable start on the local boys. The same article states that Eddie Cantor has been conferring with the Scophony interests, and will probably become associated in the venture.

WHAT THEY SAID

That American mfrs. have been caught napping is indicated by their replies to the RTD special questionnaire, though the cos. seem reluctant to disclose their plans, if any. It would
(Continued on page 436)

"Mars War" Scare Brings Listener's License Rule

As a result of the nation-wide terror caused by the Orson Welles broadcast "War of the Worlds," the Federal Radio Commission has determined that radio listeners must secure government licenses to own and operate receivers. No fee is to be charged for these licenses, but listeners will be required to prove that they have an I.Q. (Infantelligence Quotient) equal to that of a 10-year-old.

(NOTE:—And if you believe this story, you'd never pass the test!)

"GOOD MORNING, JUDGE"



says RCA's L. W. Teegarden to R-C's R. D. Washburne, a judge in "Nipper" Contest. Five entrants tied for 1st prize; each got \$1000 for nearest guess on total spent advertising trademark pup.

RMA Legislative Committee Active

The RMA Legislative Committee is preparing to combat harmful legislation when state legislatures meet in Jan.

They are also expected to combat the renewal of the 5% radio excise tax law which will expire in June.

SIDE ROADS TO EXTRA PROFITS

*Mfrs. & Dtrs. Find New Dollars
In Side Lines—RTD Survey
Gives Inside Tips*

The now famous RTD Questionnaire has answered many questions long puzzling the trade. It now answers one of the most important, namely, "How can I make more money?"

The answer is to be found in *side-lines*—sidelines for the manufacturer to make and for the dealer to sell. In the replies, the number responding to the question relating to Manufactures bore the same relation to those relating to Sales as 6 does to 7, though the majority of the answers came from those engaged in manufacture.

HINTS FOR MFRS.

Here, then is a tabulation of replies, first as relating to sidelines which should prove profitable to those en-
(Continued on page 437)

RCA THEATER DEAL TO PLUG TELEVISION

RKO theaters are expected to work with RCA in putting over television. Theaters will probably show trailers boosting telly, & use lobby displays to plug the new art in return for sets to pass out as screeno, bingo & bank nite awards.

What? No dishes?

WORKED FOR 156 YEARS IN SAME JOBS



A total of 156 years with G-E—that's the record of these 3 youngsters. Left to right: George S. Jameson, 50 yrs., Roderick S. McNeil, 51 yrs., & Charles J. Leephart, 55 yrs. Each was given an engraved certificate and a diamond studded pin at the co.'s 60th anniversary party. Congrats, gentlemen!

EYE-GRABBING DISPLAY



Now that football season is ending, National Union turns to pretty girl—on which season never ends—for ultratractive 2 x 4 ft. window card. No particular tube tie-up, but oh so pretty!

How Many Nets?

Laymen usually think of 4 to 6 radio networks in U.S. Actual count is 3 nationals (NBC, CBS & MBS) and 18 regionals, according to FCC.

But really FCC count is short, for major nets are split into smaller localities, as look at NBC or CBS rate card will verify. Indeed, NBC itself is split into 2 nets (Red & Blue). So almost any figure you guess is good—depending on what you call a net.

Personal

HOWARD BRIGGS, v-p of Howard Radio Co., reports biz on the upswing in the south. He appointed McGowan-Lyons Hardware Co., of Mobile, Ala., as Ala. distributors of the line.

CHARLES B. SHAPIRO, Howard Radio's sales mgr., motored from Chi. to the coast, stopping off for contacts on the way.

MAX & SAM KASSOVER of Vim Radio Co., JULES M. SMITH & HERMAN M. STEIN of Davega-City Radio have been named co-chairmen & HENRY BENJAMIN of Davega has been named honorary chairman of the Radio & Musical Instruments Division of the N.Y. & Bkln. Federations of Jewish Charities.

H. A. MARSH of the Marsh Adv. Agy, 307 5th Ave., N.Y.C., is now handling the Triad Tube acc't.

(Continued on page 437)

CREATES INTERFERENCE



So that dealers & Servicemen may demonstrate effectiveness of RCA-Victor noise eliminators & master antennas, this gadget has been provided for use in home or showroom. Co.'s sets with 8 or more tubes have such noise-reduction equipment provided—and items work as claimed, too.



Rumors on Radio Row are that N. Y. *Eve. Post* is paying \$4 each for those RCA record players which it is giving away free to folks who buy batch of records at low price . . . Now the NBC net has 160 stations, with WAPO the latest . . . Philco is plugging Mystery Control with most promotional material in co.'s history. 75,000 visitors to a state fair were eager to try the dial . . . Tests in Sylvania factory indicate better work when phonos play 2 records of "slow swing" every half-hour.

More stinging slaps from the FCC have blistered International Radio Corp., Ann Arbor, Mich., & Sales-On-Sound Corp., N.Y.C. . . . Dealer tie-ups are urged for the new Emerson ad campaign, with mats being provided . . . ACA News is putting up a scrap to end 16-hr. days for ship ops.

Rumors that Crosley will be making & selling a \$200 2-cylinder car (swell for Servicemen!) by Jan. 1 are strictly the bunk—but he is working on it . . . Amer. Television may come back to life

(Continued on page 437)

DISPLAY SHOWS VALUE OF "BIG 6" DEAL

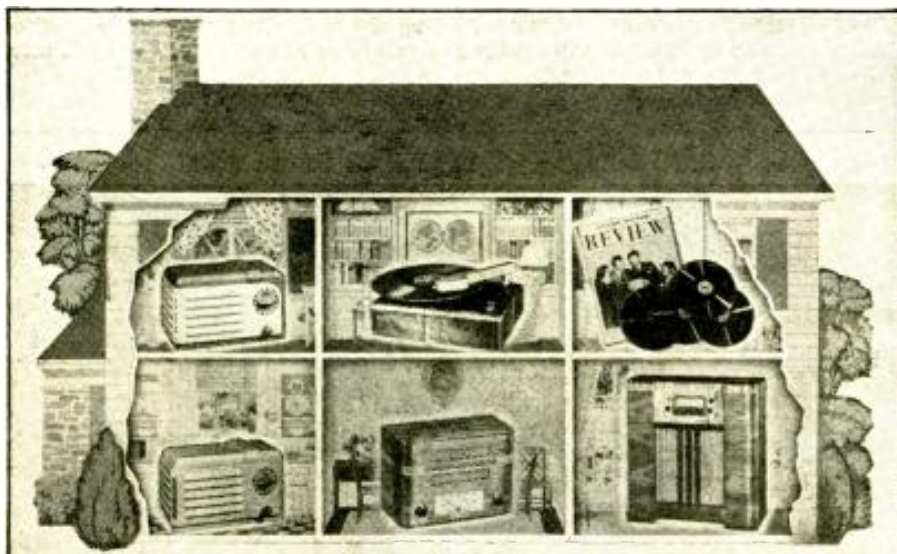

A 7-tube electrically-tuned console, 3 table models, a playback unit, \$9 worth of records, & membership in the Victor Record Society are included in the RCA \$159.90 customer deal—and this display helps drive home the value to bring sales to the dealer.

The RSA Monthly Bugle

(News of the Radio Servicemen's Assn.)

Allentown, Pa., & Hartford, Conn., are affiliating with RSA.

As of Jan. 1, 1939, RSA dues will be \$3 a year, with \$1 initiation fee. Better hurry to beat the rise.

The Assn. is working out a guarantee for its members to give the public.

At the Chicago chapter's Sept. meeting, the test equip't show was so good that it'll be an annual feature.

The Cleveland chapter threw big picnic, and did the gang love it!

The Dallas boys have been spending their time working up fall promotions.

Servicemen for 100 miles around attended the Duluth chapter's Jamboree at the Hotel Spaulding. The chapter's charter was presented at this shindig.

Each of the 5 N.Y.C. chapters received its charter from Joe Marty, Jr., exec. sec'y of the RSA, at a jernt meeting.

Amateurs & Servicemen got together for a sports outing at Lake Sunapee, N. H. A real g.t. was h. by a.

AN EDITORIAL

By Artie Dee

Now you've seen it!

Elsewhere in this issue there is a description of the RADIO-CRAFT Radio Home—wired for radio. It is the life-saver the trade has needed for so many years.

Analyze the plan. It calls for a far greater investment in radio equipment than has ever before been made by the average home. It provides the home-owner more radio entertainment, giving him radio in every room, with localized control of tuning and volume. It assures him of a sound, easy payment plan, for equipment thus installed is part of the home, and should therefore be amortizable over a 20-year period under the FIAA. (If the FHA doesn't think so, the RMA can doubtless show them their error.)

From the dealer's point of view, it can't be beat. If the FHA finances the job, the dealer is assured of prompt, full payment. And, even though the installation is part of the house, the radio receiver itself is a detached unit. It can be replaced when it becomes obsolete or outmoded, so that it will not kill resale possibilities.

Do you like it? Do you want to start making money under this new RADIO-CRAFT plan? If you do, there's nothing to it. Simply get together with the builders in your locality and make your deal with them. Have them advertise their houses as "Wired For Radio"—and make sure that you have a signed contract with them for the work. Arrange the deal in any way that is mutually satisfactory, and get started after those new dollars. *Go to it!*

Hot Sales Stunt

The hunt system, long used by editorial typists (hear! hear!—Ed.), prevails in the 6-floor store of N.Y.C.'s Leotone Radio Co., the brainchild of Leo Sharon.

Hard-to-get parts, voice coils, stuff needed to put an obsolete set in tiptop shape are scattered through hundreds of pans on dozens of counters. No filing system is used. Purchasers can either have the thrill of the chase nosing out bargains or can ask Leo. One second's pause, and he can make a bee-line to the wanted item.

SEATTLE BATTLE

With Seattle, Wash., papers barring radio columns to all, & programs to all but biggies, stas. are unworried. Two local giveaways feature programs.

Papers fear to drop pros. lest circulation slump; meanwhile stas. continue sending releases, regardless of waste baskets.

BIZ OPPS

There's business for those who will take the trouble to go after it. Here are 3 chances. Are they in your line?

"I am opening a radio shop and would like to have my name on a mailing list of any radio parts manufacturers" *writes Stanley Conn, 107-5th St., Aurora, Ind.*

"Could you let me have a list of American electrical firms from whom I can get catalogues? I have a chance to sell electrical goods (not shades nor lamps)", *requests Serviceman H. C. Ferdinands, 5 Cleveland Ave., St. Heliers, Jersey, Channel Islands.*

"Please put us in touch with some American manufacturers of automatic pushbutton units for radio receivers. We are specially interested in D.C. motor-tuning pushbutton units, or only D.C. tuning motors," *asks Western Wireless Co., Post Box 804, Asian Bldg., Nicol Road, Ballard Estate, Bombay, India.*

CIO GETS SOCKED

When engineers of CBS Chi. station voted under NLRB for bargaining agent, ballot for independent Amer. B'est Technicians was 128; for CIO-affiliated Amer. Communications Assn., 60.

MAP ON TUBE CARTON



To stress world-coverage of radio, RCA puts 4-color map of world on new power tube cartons. Nothing fancy—just plain red, yellow, blue & green—made in 3 sizes.

Changes & New Addresses

EICOR, INC., 515 S. Laflin St., Chicago, Ill., will make & sell dynamotors, converters & gas electric plants. Officers of the new co. are Joe Nader, pres. & chief engineer; R. D. Wright, v-p & sales mgr.

AMERICAN COMMUNICATIONS CORP. has moved factory & offices to larger quarters at 123 Liberty St., N.Y.C. They make oscillators, code readers, burglar alarms & a centralized radio system for hotels, hospitals, etc. (Continued on page 437)

WINDOW DISPLAY ADVERTISES ADVERTISEMENT

Besides showing leaders in the Emerson line, this colorful window display features a full-page full-color ad which was run in American Weekly Part of display (not included in picture) is open-top table model phono-radio.

Sales Helps and Deals

TRIPLETT INSTRUMENTS has concluded a contest with a \$250 1st prize for best letters on how a puzzling service problem was solved with test equip't. Winners will be announced next mo.

RCA-VICTOR offered \$250 cash for each of the earliest Vics made in each of the years from 1906 to 1925. Entries will give a grand list of prospects for new outfits. Dealers forwarding winning entries stand to win equal amounts, provided they filed photos of windows plugging the contest. Smart tie-up, Nipper.

G-E pre-Xmas ads feature slogan "For Practical Person with Sentimental Side," or vice versa. Plugs used include mags., papers, bests, windows, floor displays, counter cards, takes, wrappings. Dept. stores are given booklet on "101 Ways to Ride in on G-E's Christmas Promotion."

THESE BOYS GO PLACES

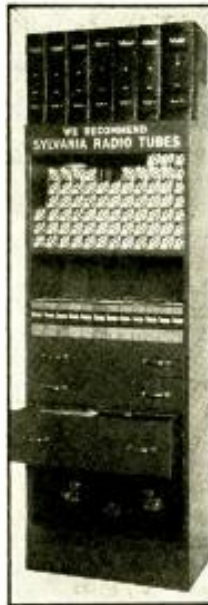

C. J. White, Woodruff, Wis., Serviceman, says the set he installed on this motorcycle has a dependable 300-mi. day & night range. Extreme left, the Sylvania Stock Boy now adds book ends & a built-in cash box. The Noggle Products Co. Add-A-Bin, can lock open or close automatically; assembles to any size & shape.

Bugs Breaking Out In Mystery Control

Tips from A Certain Mfr.'s service sheet reveal unsuspected bugs in mystery control. Here are a few of the hints:—

- (1) If the control box is near a large metal object (like a girder in the wall or sump'n') it won't operate the set from much of a distance.
- (2) If the set's sensitivity control is set for "near," the remote won't work well for more than 30-odd ft., but if it's set for "extreme," while it will pick up control signals from 72 ft. away, bursts of static are apt to tune, retune or detune the rig.
- (3) There's a possibility of 1 control affecting 2 sets on the same floor. But this particular bug can be fixed up.

\$'s & N^{o.}'s Dept.

UPS & DOWNS. Best billings for the 9 mo. ending Oct. 1 showed NBC & MBS up over 1937, with CBS down. This yr.'s totals:—NBC, \$29,902,724; CBS, \$19,975,882; MBS, \$1,874,255.

DUBILIER DIVIDEND. Cornell-Dubilier issued a dividend of 10c per share on all common stock. New products are credited with this co.'s sales increase.

ADVERTISERS' AVERAGES, according to MBS for its own net, are:—
(Continued on page 436)

OFF THE PRESS

TRADE-IN ALLOWANCE BLUE BOOK. A section of Radio Retailing, Sept., suggests fair trade-in prices on used 1933-37 sets.

RADIO PHOTO LOG. 32 pp. National Union Radio Corp., Newark, N. J. Station log and pix of stars—with plenty cheesecake.

REVISED STANDARD ELECTRICAL CHARACTERISTICS for 2-WAY REPRODUCING SYSTEMS. 8 pp. Academy of Motion Picture Arts & Sciences, Hollywood, Calif.

NATIONAL FARM & HOME HOUR. Broadside. National Broadcasting Co., N.Y.C.

CIRCULAR 507. 4 pp. Ward Leonard Electric Co., Mt. Vernon, N. Y. Resistor catalog.

CATALOG 161. 40 pp. Cornell-Dubilier Elec. Corp., S. Plainfield, N. J. Capacitor catalog.

A SYMPHONY A DAY. 16 pp. NBC, N.Y.C.
(Continued on page 437)

THREE WIN BEAUTY PRIZES

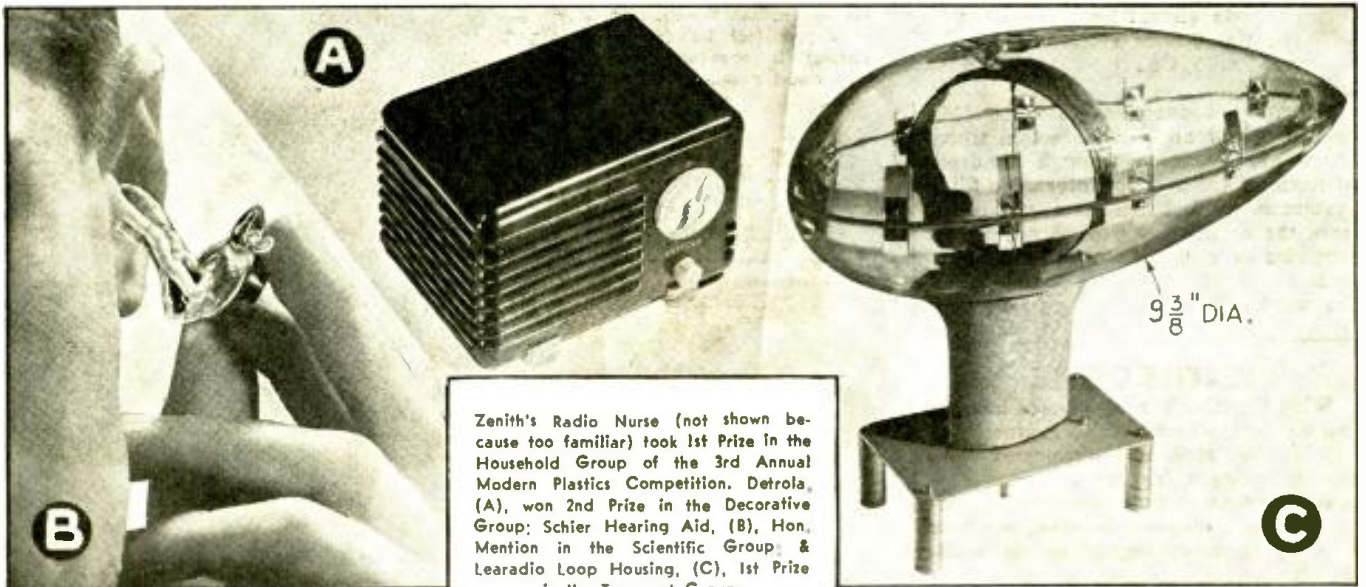

Zenith's Radio Nurse (not shown because too familiar) took 1st Prize in the Household Group of the 3rd Annual Modern Plastics Competition. Detrola, (A), won 2nd Prize in the Decorative Group; Schier Hearing Aid, (B), Hon. Mention in the Scientific Group; & Learadio Loop Housing, (C), 1st Prize in the Transport Group.

SUPERIOR PRESENTS 5 INSTRUMENTS

from its NEW 1100 series!!!! Never before has Superior offered so much for so little! Always the Best Buy in the Instrument Field, Superior in this new 1100 series gives you even more value! We have incorporated many refinements, many new features . . . all proven to be sound and practical. We urge you to read the descriptions below carefully; see how these instruments fit your needs. Buy direct from manufacturer and save 50%.

ments, many new features . . . all proven to be sound and practical. We urge you to read the descriptions below carefully; see how these instruments fit your needs. Buy direct from manufacturer and save 50%.

SUPERIOR INSTRUMENTS ARE GUARANTEED FOR ONE YEAR

THE NEW MODEL 1110-S A.C. - D.C. VOLT OHM MILLIAMMETER A Midget in Size—A Giant in Performance



Features modern 0-1 d'Arsonval type meter, precision resistors, neat etched panel housed in new striped fabricoid case.

SPECIFICATIONS:

0-1.5 volts D.C.	0-500 ohms.....500-500,000 ohms.	0-15 volts A.C.
0-15 volts D.C.	0-1 ma. D.C.	0-40 volts A.C.
0-25 volts D.C.	0-10 ma. D.C.	0-75 volts A.C.
0-75 volts D.C.	0-100 ma. D.C.	0-200 volts A.C.
0-500 volts D.C.	0-500 ma. D.C.	0-1200 volts A.C.

Model 1110-S supplied complete with batteries, test leads and instructions. Size: 8½" x 5" x 3¼". Shipping weight, 5½ pounds. Our net price. **\$7⁸⁵**

THE NEW MODEL 1130-S Signal Generator with Audio Frequencies



SPECIFICATIONS:

1. Combination R.F. and Audio Signal Generator. R.F. 100 kc. to 100 Mc. A.F.—100-7,500 cycles. All Direct reading, all by front panel switching.
2. R.F. and A.F. output, independently obtainable alone or with A.F. (any frequency) modulating R.F.
3. Accuracy is within 1% on I.F. and Broadcast bands; 2% on higher frequencies.
4. Audio frequencies in 5 bands; 100, 400, 1000, 5000, and 7500 cycles.
5. Giant airplane full vision, direct-reading dial.
6. Condenser and other leakages tested to 100 megohms.
7. All services on 90-130 volts A.C. or D.C. (any frequency).

Model 1130-S comes complete with tubes, test leads, carrying handle, instructions. Size 12" x 9" x 6½". Shipping weight 15 pounds. Our net price. **\$11⁸⁵**

THE NEW MODEL 1150-S SUPER-ALLMETER Featuring the New Sloping Panel



A genuine achievement! For accurate and rapid measurements. Note the following features: A.C. and D.C. Volts, A.C. and D.C. currents, Resistance, Capacity, Inductance, Decibels, Watts.

SPECIFICATIONS:

D.C. Voltage: 0-15, 0-150, 0-750 volts D.C.
A.C. Voltage: 0-15, 0-150, 0-750 volts A.C.
D.C. Current: 0-1, 0-15, 0-150, 0-750 ma. D.C.
A.C. Current: 0-15, 0-150, 0-750 ma. A.C.
2 Resistance Ranges: 0-500 ohms
500-5 megohms
High and Low Capacity Scales: .0005 to 1 mfd. and .05 to 200 mfd.
3 Decibel Ranges: -10 to +19, -10 to +39, -10 to +53.
Inductance: 1 to 700 Henries
Watts:
Based on 6 mv. at 0 D.B. in 500 ohms. .006000 to 600
Utilizes new 4½" square 0-1 d'Arsonval type meter with precision resistors housed in our newly devised sloping case for rapid and accurate servicing.
Model 1150-S supplied complete with test leads, tabular charts and instructions.
Size 10" x 7¼" x 1½", shipping weight 9 pounds. Our net price **\$11⁸⁵**
Model 1150-A Portable carrying cover 75c additional.

THE NEW MODEL 1180-S SET TESTER A Complete Laboratory All in One Unit!

Featuring Our New Type Sloping Panel for Precise and Rapid Servicing



A complete testing laboratory all in one unit! Comes complete with test leads, tabular charts, instructions and tabular data for every known receiving type tube, including many transmitting types. Size 11¼" x 9¼" x 5"; shipping weight 18 pounds Our net price **\$17⁸⁵**
Model 1180-A for Portable Cover, add 95c.

THE NEW MODEL 1140-S TUBE TESTER



A really modern tube tester conforming to all standards of good engineering practice. Utilizes a 3" d'Arsonval type meter with calibrated scale. Furnished in a sturdy black case with sloping panel for easy operation. Removable cover and carrying handle for either portable or counter use.

SPECIFICATIONS:

1. Tests all 4, 5, 6, 7, 7L, and octal base tubes, including diodes.
 2. Tests by the well established emission method for tube quality, directly read on the GOOD? BAD? scale of the meter.
 3. Affords separate neon test for leakage and shorts between elements.
 4. All services performed by the use of only five controls at maximum, and many tests do not require working all the controls.
 5. Supplied with instructions and reference table so that the filament voltage and emission measuring controls may be properly set for the enumerated long list of tubes, which includes all tubes commonly encountered in servicing.
 6. Works on 90-120 volts A.C. 60 cycle.
- Model 1140-S comes complete with instructions and tabular data for every known receiving type of tube as well as many transmitting types. Shipping weight 10 pounds, size 10" x 7¼" x 4½". Our net price **\$10⁸⁵**
Model 1140-A with Portable Cover 75c additional

SUPERIOR INSTRUMENTS CO. 136 Liberty St., RC-139
NEW YORK, N. Y.

Please Say That You Saw It in RADIO-CRAFT

SEARS, ROEBUCK & CO., SILVERTONE "ROCKET" MODELS 6110 AND 6111
(Chassis No. 101.508)

5-Tube T.R.F. Receiver; Mechanical Pushbutton Tuning; Broadcast Band Only; (545 to 1,720 kc.) Auto-Power Transformer; Power Output (Max.) 1.6 Watts.

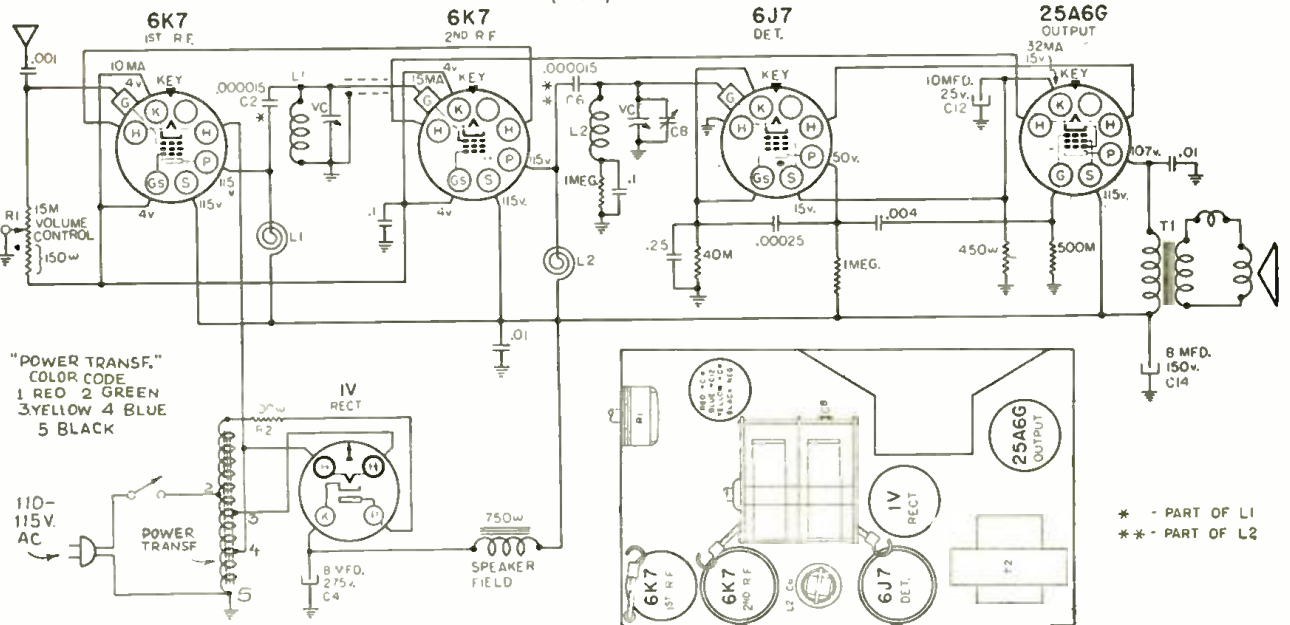

Schematic diagram of the Silvertone Models 6110, 6111. Alignment frequency, 1,400 kc. Voltage readings are from socket prongs (underside view) to chassis with no-signal input; line voltage 115 volts; volume control full on.

SETTING THE PUSHBUTTONS: Unlock the mechanism by loosening the screw at the center of the tuning knob, for a few turns. Push the button all the way in and tune-in the desired station while the button is held in firmly. Then release the button before tuning-in the next station. Proceed in the same manner for the remaining buttons. Lock the mechanism by tightening the screw in the tuning knob.

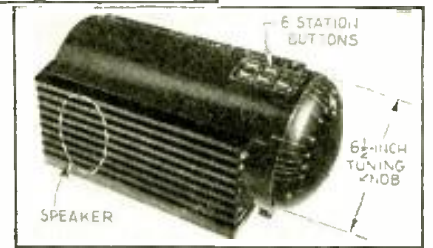

ZENITH MODELS 6D302, 6D311, 6D326, 6D336, 6D360 (Chassis 5646)

5-Tube Superhet.; Broadcast Band Only; Beam-Power Output (3 W.); Automatic Volume Control.

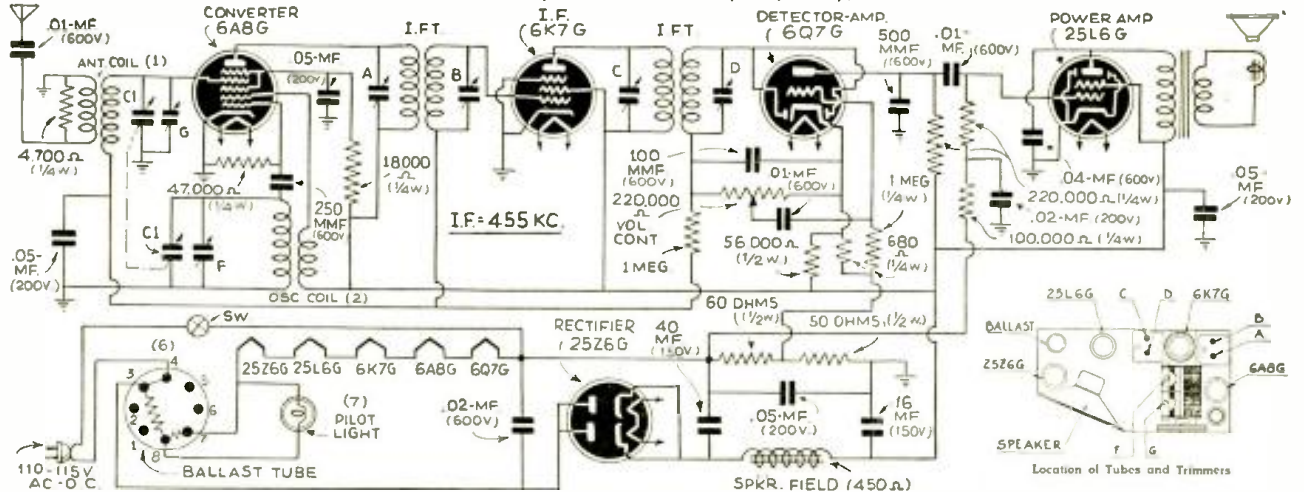

The terminal voltages—in the numerical order of the terminals and in the following order of the tubes: ballast, 6A8G, 6K7G, 6Q7G, 25L6G and 25Z6G—are as follows: 1—(shell) 0 for all tubes; 2—0, 2 A.C., 10 A.C., 2 A.C., 30 A.C., 30 A.C.; 3—94 A.C., 90, 83, 50, 80, 94 A.C.; 4—94 A.C., 50, 90, (A), 0, 115; 5—0, -5, 0, (A), 10 A.C., 94 A.C.; 6—9, 90, 0, 0, 0, 0; 7—50 A.C., 5 A.C., 5 A.C., 0 A.C. ("C" 7 V. P.C.), 90, 30 A.C.; 8—54 A.C., 0, 0, -1.6, (B), 115. A cross field, 25 V.

Voltages from socket to chassis with 1,000 ohms volt meter: full volume; antenna disconnected; line, 115 V. Legend: (A)—Bias of 6A8, 6K7, 6Q7 measured at 6Q7 cathode. (B)—Bias for 25L6 measured between "C" at 6Q7 socket and chassis.

PURPOSE	CONNECT	ALIGNMENT PROCEDURE	SET DIAL TO	ADJUST TRIMMERS
I.F. Align.	OSC. TO 1st det. grid	DUMMY ANTENNA	OSC. FREQ.	A, B, C, D,
Dial Align.	Ant. lead	1/2 mf.	455 kc.	F,
Ant. Align	Ant. lead	200 mmf.	1,500 kc.	G
		200 mmf.	1,500 kc.	

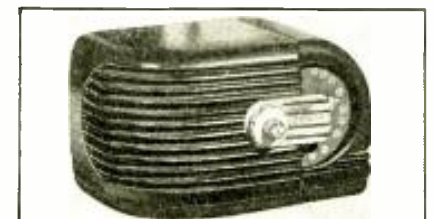

ALLIED RADIO CORP., KNIGHT MODEL EI0913 (CHASSIS 118B)

4-Tube Battery Superhet.; Uses New 1.4-V. Tubes; P.M. Dynamic Speaker; Single 1,000-Hour Battery; "A" Drain Only 0.2-A; "B" Drain Only 8 ma.

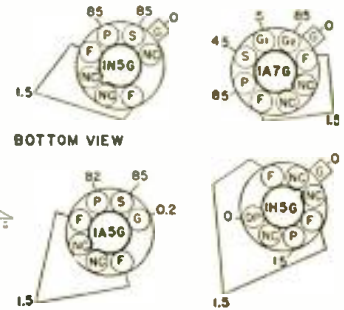
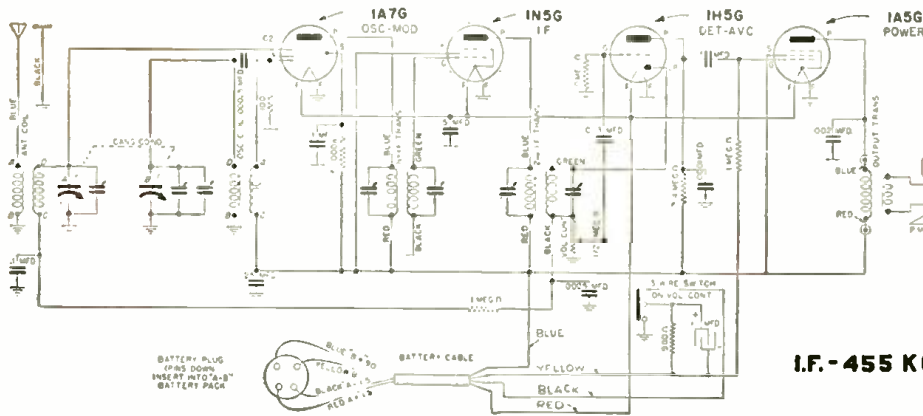

I.F. - 455 KC.

Voltage measurements from socket contacts to ground with 1,000 ohms/volt meter; 90 volts "B"; 1 1/2 volts "A"; "NC" above means no connection.



Above, schematic circuit of the battery receiver illustrated at left.

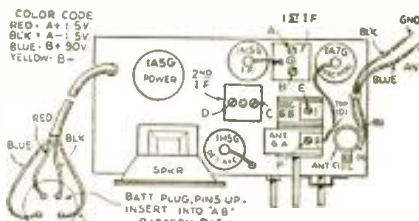

Chassis layout and trimmer locations.

ALIGNMENT

Before starting alignment, check the tuning dial adjustment by turning the tuning condenser to full capacity and moving the dial needle to line up with the last line at the low-frequency end of the dial scale. Align the set in the order given:

Set Dial To:	Dummy Ant.:	Attach Osc. To:	Oscill. Freq.:	Adjust Trimmers:
Any off-station point	0.02-mf. condenser	1A7G grid, do not remove cap.	455 kc.	A, B, C, D, E
1,730 kc.	250 mmf. condenser	Set antenna lead	1,730 kc.	E
1,400 kc.	250 mmf. condenser	Set antenna lead	1,400 kc.	F

GENERAL ELECTRIC MODEL GD-52

5-Tube Superhet.; A.C.-D.C.; Pushbutton Tuning; Automatic Volume Control; Range. 540-1,750 kc.



General Electric Model GD-52.

ALIGNMENT PROCEDURE

I.F. Alignment
Connect an output meter across the voice coil. Set the volume control for maximum.
Set test oscillator to 455 kc. and apply signal to the control grid of the 6A8G tube through a 0.05-mf. condenser. Do not remove the grid lead from the 6A8G and keep the test oscillator output as low as possible to give a readable output. Adjust all four I.F. trimmers for maximum output.

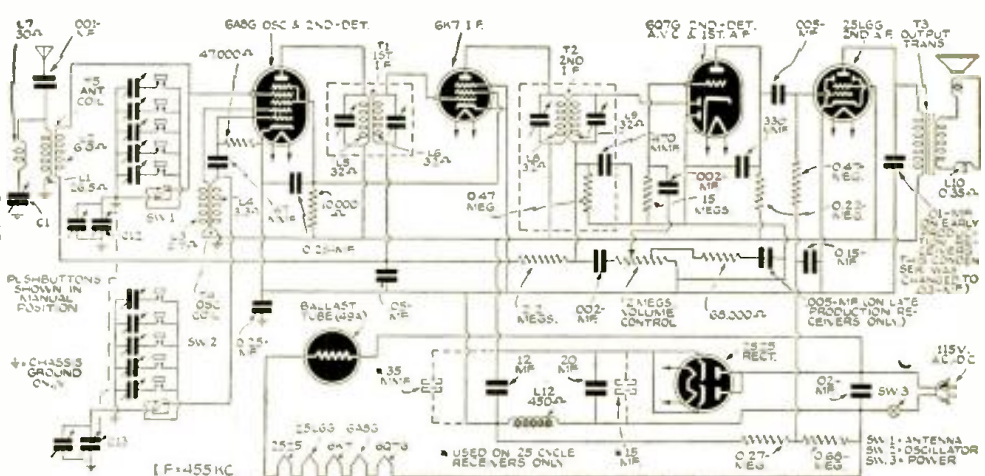

Schematic diagram of the General Electric Model GD-52 superheterodyne receiver.

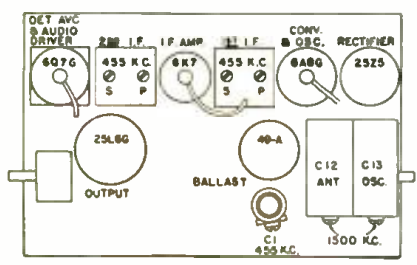

Chassis layout and trimmer locations.

Wavetrap Alignment

Leave the test oscillator set to 455 kc. and connect one output lead to the receiver chassis and the other through a 250 mmf. condenser in series with 200 ohms to the receiver antenna lead. Adjust (C1) for minimum output.

R.F. Alignment

Use the same dummy antenna (250 mmf. and 200 ohms) with 1,500 kc. input, adjust the oscillator trimmer (C13) and antenna trimmer (C12) for a maximum output.
Precaution—One side of the power supply is connected to the chassis through a 0.25-mf. condenser. If signal generator is A.C. operated, connect a 0.05-mf. condenser in the ground side before connecting it to the receiver chassis.

VOLTAGE TABLE

TUBE	6A8G	6K7	6Q7G	25L6G	25Z5
Plate to "B"	115	115	55*	110	—
Screen-grid to "B"	75	75	—	115	—
Cathode to "B"	0	0	0	0	115
Cathode Current in Ma.	6.4	1.4	0.5	37	47
Filament Volts	6.0	6.0	6.1	24.5	211

Line Voltage—120 A.C.; no signal input; on D.C., voltages are about 15 per cent lower.
*Measured on 250-volt scale.



The
AMPERITE
ACOUSTIC
COMPENSATOR

gives you
HIGH OR LOW PITCH
WITH THE SAME MICROPHONE

With the flip of a finger you can now (1) lower or raise the response of the microphone... (2) adjust the microphone for most desirable response for close talking or distant pickup... (3) adjust the system to any "taste", room condition, or equipment.

MODELS RBHk. RBMk. with Acoustic Compensator, frequency range 40 to 11000 cps, output .65 db., complete with switch, cable connector and 25' of cable..... \$42.00 LIST

NEW! MODEL RSHk (hi-imp): RBSk (200 ohms) Frequency range 60 to 8000 C.P.S. Output -68db. . . . Chrome or Gun-metal \$32.00 LIST

NEW LOW PRICE CONTACT "MIKE"
ModelSKH (hi-imp); SKL (200 ohms) \$12.00 LIST

MODELS RAH-RAL, excellent for speech and music. Reduce feedback..... \$22.00 LIST

Write for Complete Illustrated Bulletins and Valuable Sales Helps.

AMPERITE Co. 561 BROADWAY, N. Y.
Cable Address: Alkorn, New York

AMPERITE Velocity **MICROPHONE**

CONSISTENTLY



DEPENDABLE

NEW CATALOG #161
JUST OFF THE PRESS
May we send you a copy?

CORNELL - DUBILIER
ELECTRIC CORPORATION
1014 Hamilton Blvd.,
So. Plainfield, N. J.
Cable Address: CORDU

THE TERRY-HOLDEN JUNGLE EXPEDITION

(Continued from page 392)

ture to steam which acquires enough pressure to actually explode the tooth—an extremely painful process.—*Editor*)

Dr. Holden also had the job of explaining radio to a group of Indians who came to his camp on the upper Essequibo from about 200 miles distant. Somehow the information got abroad that the white men had some strange devices and in came a troupe of Indians all set to inspect the apparatus. They listened and wondered. Dr. Holden pointed to the air, but the mystery became as thick as gumbo. Finally, the expedition leader took his microphone as far afield as the line would allow, let some speak into it and others listen at the loud-speaker.

Indian eyes brightened as something of the meaning of these strange instruments began to penetrate. They talked, laughed and sang native songs in turn, proving that there's a little of the radio entertainer in everyone. It was one of the disappointments of the expedition that these Indian songs could not be transmitted to the United States.

But, having seen and understood after 2 days in the Holden camp, the Indians quietly disappeared into the thick British Guiana bush.

The Terry-Holden Expedition set out from Georgetown, British Guiana, last September ('37) in specially-constructed boats propelled by outboard motors. The party of about 40 persons carried radio equipment supplied by N.B.C. They went up the Essequibo River, branched off on the Rupanuni and in 6 weeks traversed about 400 miles. Occasionally it would be necessary for all to disembark, remove the tons of cargo and tow the boats through foaming rapids. A base radio camp was established at Ishertun and a broadcast was made over N.B.C. from that point. Two members of the party were left to operate the radio station in Georgetown and maintain contact with N.B.C. in New York.

The rest of the party pushed on, made a portage to the Kuyuwini River and later rejoined the Essequibo. The Christmas broadcast came from Onoro, where Dr. Holden slashed away jungle to erect an antenna for his portable radio transmitter and talked, through the base camp, to New York and the Arctic.

RADIO EQUIPMENT

At this camp, the main radio equipment was installed. It comprised a 200-watt transmitter supplied with a speech amplifier of 18 watts, an RCA receiver, loudspeakers and other equipment, all of which was constructed to allow for the humidity and high temperatures of the region.

Two gasoline motors generated the power supply for the transmitter, and a diamond-shaped directional antenna was used to maintain direct communication with Riverhead, Long Island.

Says Dr. Holden, "This photograph of Dr. Nelson De Oliveira (right) and myself was taken on the Rio Mapuera exactly at the point where we crossed the Equator. This was the first outpost we reached of the Brazilian Boundary Commission. Dr. De Oliveira was physician and officer in charge of this outpost. It was through him that we received such wonderful treatment from the Brazilians. They gave us every aid and rendered no end of assistance to us in reaching the Amazon. I cannot speak too highly of the Brazilian Boundary Commission."

In addition to the base camp radio equipment, the party had a portable radio set with a transceiver consisting of a crystal-control transmitter, and a shortwave receiver, the set operating on power provided by a hand-driven field generator.

By means of the portable set, Dr. Holden, operating in the field, maintained 2-way contact with the base and relayed broadcasts to the outside world. The important role of this set, however, was that of charting the bearings of Dr. Holden's outpost party as it progressed into the deepest part of the jungle.

Using the same principle of triangulation by which RCA's radiomarine direction finder functions, he was able to find his position in the jungle by maintaining communication on the one hand with the base camp and on the other with the radio station at Georgetown.

In this fashion, he was able to remove one of the great hazards of his trip—that of being lost in the uncharted jungle. By means of the portable set which has a range of about 200 miles, Dr. Holden was able to go farther from his base than would otherwise have been possible.

Dr. Holden and William Hassler, zoologist and official photographer, parted from the 2 remaining white men in the party and set out with a few native guides to make the hazardous first crossing of the Akari Mountains, on the border between British Guiana and Brazil. Food was already short, the heat was terrific and the slow passage up the steep slopes through undergrowth at times made the task seem impossible. The Indians were frightened at penetrating an unknown country and so tired at times that they lay down and wept from sheer exhaustion.

On the other side the descent was swift. Natives of the countryside, however, were incredulous; they refused to believe that Holden and his party had made the crossing. No one had ever before come from that direction. In search of food the party visited 3 Indian villages, but the results were meager.

One such trip was made to a village 15 miles from the river. Night fell before the party could return. Anxious to be with their belongings, piled on a rock beside the river, Holden sent 3 Indians on ahead to procure torches. They ran, one dropping off at each 5-miles interval. The last returned from the river, passed on the torches to the second and the third finally met the party. A rain during the night caused this tributary of the mighty Amazon to rise 6 feet. Had the party not returned all of their supplies would have been swept down the raging river. "We might have been there yet," mused Dr. Holden.

RADIO OPERATOR

Radio may be old stuff in the United States, but the citizens in the interior of British Guiana still do not understand it,



Please Say That You Saw It in RADIO-CRAFT

according to Orison W. Hungerford, radio operator of the Terry-Holden Expedition station VP3THE, who relayed a series of programs from the tropical jungle to the National Broadcasting Company networks.

"Our camp was some 600 miles up the Essequibo and Rupanuni rivers," said Hungerford on his arrival in New York City, "and after we set up the radio shack we began to receive visitors. For a couple of weeks the most faithful of these were a group of Wei-wei Indians, who came to inspect the radio equipment and everything else we had. These Indians, who came decked out in their finest paints, must be the most curious people in the world. They didn't steal anything, but they did inspect everything around the radio shack. If there was something they didn't understand they'd simply break out in loud laughter. It took radio to make them serious.

"The ringleader of these Wei-wei Indians was a tall, handsome fellow. One night when we were working and our visitors were all gathered around I put the earphones on this fellow's head. Blank amazement. His eyes moved first to left, then to right. I took the phones off a minute and he still stood there. All this time there was never a word except those he heard through the earphones. He gave one final look around the shack and then turned on his heel and walked out. All the rest followed in silence. And that was the last we saw of our Wei-wei friends. They're probably walking yet."

The greatest curse of tropical radio, according to Hungerford, was the insect. The nightly yield of electrocuted bugs averaged one quart. "A bee short-circuited a switch one night and almost put me off the air," he said.

"Probably no one knows how close we came to not keeping our date for last New Year's broadcast. The motor driving our generator stopped just before we were due to go on the air. It was raining as it rains only in the tropics. So we rushed out to fix it, dressed only in pajamas. Of course we were soaked, but we kept our date with the N.B.C. audience. This was at night, when it gets cold even in the jungle. Neil MacMillan, my fellow operator, took the microphone. He was shivering from both mite fright and the cold. So I dug my fingers into his shoulder to keep him from knocking the microphone off the table. And all this time he was talking about 120 degrees in the shade." Transmission conditions, he added, were excellent.

Although he spent some 7 months, including 158 days in the interior of British Guiana, and suffered from hunger and bad food, the young engineer is ready for another such trip.

THE RADIO MONTH IN REVIEW

(Continued from page 391)

from time to time to meet changing atmospheric conditions, and facilities are provided to vary the wavelengths in a few minutes. This can be accomplished because the circuits for the high-power stages are built on a rotating turntable."

High-fidelity station WQXR considers only the New York metropolitan area as the coverage of its 1,000-W. station on 1,550 kc., but recent "sky wave" reception makes Alan Hutchison of Dunedin, New Zealand, an enthusiastic listener-in.

Did you hear WQXR last month? Can you pick up at least 1 of the 4 "hi-fi" stations in the U. S.?

at Zenith ONLY THE "IMPOSSIBLE" TOUGH ONES ARE RETURNED FOR A SUPREME CHECK-UP!



New Model 571 Signal Generator

FUNDAMENTAL 65 kc. to 20.5 mc. . . . Five bands read on only two scales . . . Reads like a meter scale . . . Unlimited range on harmonics . . . Illuminated dial . . . Shadow tuning . . . Dual ratio knob . . . Variable iron core coils . . . Air dielectric trimmers . . . Two percentage levels of amplitude modulation 30% and 75% . . . Sine wave demodulated wave form . . . Frequency 400 cycle note unchanged when percentage modulation changed from "high" to "low" . . . replaces multi-vibrator . . . 400 cycle wave used externally or can be modulated externally . . . High output 0.1 volt all bands . . . Full instructions . . . Step by step receiver alignment procedure . . . Write today for new literature . . . Get the amazing story of an amazing new instrument . . .

"IT'S here where we bring the tough ones", says Frank E. Smolek, Service Manager, Zenith Radio Corporation. "After every effort has failed in the field these 'impossible' sets are returned to us for a complete check-up with SUPREME instruments. We have used SUPREME instruments in our factory service department for years—that is why we unqualifiedly recommend SUPREME instruments to jobbers, dealers, and servicemen."

Many familiar SUPREME instruments are illustrated in the above photograph of the Zenith Service Department. In the foreground, at right, is a new SUPREME LAB-RACK arrangement, consisting of the Model 571 Oscillator, 592 Set Tester and 596 Substitution Box. Individual models, combination portables, or many rack arrangements make SUPREME instruments your logical choice.

WRITE FOR NEW LITERATURE
SEE YOUR PARTS JOBBER TODAY

SUPREME

SUPREME INSTRUMENTS CORP.,
Greenwood, Miss., U. S. A.

Export Dept., Associated Exporters Co., 145 W. 45th St., New York City . . . Cable Address: LOPREH, New York

GET A REAL ELECTRO PLATING KIT ABSOLUTELY FREE!

Complete details as to how it is possible to get a Real Electro Plating Kit FREE, appears on Page 442 of this issue. TURN TO IT NOW!

UNIDIRECTIONAL DYNAMIC

D9T

◀ BACK—No Pickup

◀ FRONT—Full Coverage

VOLUME INCREASED by Reducing Feedback

D9T, List \$37.50, High Imp. 25' Cable

D9, List \$35.00, Low Imp. 25' Cable

Write for Catalogue No. 29

Manufacturers Full Line Dynamic, Crystal, and Carbon Microphones and Stands

AMERICAN MICROPHONE COMPANY, INC.

1915 SO. WESTERN AVE., LOS ANGELES, CALIF.



B9
Crystal
\$22.50



D7T
Dynamic
List
\$22.50

Please Say That You Saw It in RADIO-CRAFT

TODAY'S Economy TUBE TESTER offers GREATER PERFORMANCE



RCP on a tester means above all, the BEST BUY for the MONEY. RCP instruments COST LESS. PAY FOR THEMSELVES. offer advantages far ahead of more expensive testers.

RCP DYNOPTIMUM Tube Tester is an instrument so versatile and dependable, you won't believe it's a low-priced tester. Tests all tubes including ballast checks for individual interelement short and leakage. Tests each section of rectifiers and all multi-purpose tubes. Large meter 2% accurate. R.M.A. approved test circuit with specified voltages and loads. Accurate line voltage indication on meter. Also tests all pilot lights, Christmas tree lights—and 024 tubes, etc.

Model 307C **\$16.95**
Your cost

Also available in portable model (No. 307P), Only \$18.95.

Send for New Free Catalog. See the RCP line of quality low-priced testers at your jobber—or if not available in your locality, order direct and give jobber preference.

RADIO CITY Products Co.
88 PARK PLACE NEW YORK CITY

Radio Men Find This Book Handy

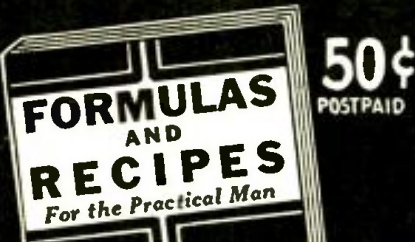

50¢ POSTPAID

FORMULAS AND RECIPES For the Practical Man

Here Is the Contents of the Book

1. Adhesives; Glues, Cements, Gums, Mucilages, Lubricants
2. Cleansing; Stain Removers, Paint Removers, Bleaches, Cleaning Fluids
3. Metal Craft; Coloring, Oxidizing, Plating, Repairing, Welding, Polishes, Alloys, Solders
4. Amalgams
5. Paints; Colors, Stains, Varnishes, Enamels, Lustrous Paint, Washable Paint; Paint-Removing, Waterproofing, Fireproofing
6. Glass-Working; Cutting, Drilling, Boring, Bending, Blowing, Etching, Engraving, Frosting, Silencing, etc.
7. Wood-craft; Fillers, Fireproofing, Acid-proofing, Waterproofing, Furniture Polishes, Finishes, etc.
8. Inks; Recipes, Eradicators, Ink Stain Removers, Special Inks, Colored, Indelible, Synthetic, Invisible, Hectograph
9. Photography; Developers, Emulsions, Fixers, Sensitizing, Toning, Printing, Photographic Paper, Blueprint Paper
10. Antidotes for Poisons, Remedies for Burns and Scalds, Disinfectants, First Aid in Accidents, Unconsciousness, Home Remedies
11. Preparation, Manipulation, Handling, Mixing, Measuring, Weighing, Filtering, Straining, Solutions; List of Technical Substances; Identifying; Use of Hydrometer; Use of Thermometer; Tables of Weights and Measures, Decimal Systems, Useful Tables.

TECHNIFAX, Division RC-139
560 W. Washington Blvd., Chicago, Illinois

TECHNIFAX, Division RC-139
560 W. Washington Blvd., Chicago, Illinois

Gentlemen: Enclosed please find 50¢ check, money order, coin, or unused U.S. stamps accepted for which send me POSTAGE PREPAID. One Copy of FORMULAS AND RECIPES For the Practical Man.

Name

Address

City State

MARCONI—FATHER OF RADIO?

(Continued from page 393)

closing the foregoing brain products of his predecessors and nothing more.

With this package of kidnaped brain products under his arm Marconi, having just reached the age of maturity, tripped off to England, and there displayed in the open tricks accomplishable with his Hertz oscillator and Branly-Popoff detector. This included sending signals 2 miles across Salisbury Plain, signals from Needles, Isle of Wight, to a tugboat 18 miles away, and 2 British war vessels separated 12 miles.

Commercialization. With information not spread throughout the world as fast as in these days, Marconi obtained the financial backing of uninformed wealthy Englishmen, and with his English patent as an asset along with future rights under his inventions, the Wireless & Signal Company was formed in July, 1897, which name was changed to Marconi Wireless Telegraph, Ltd., in 1900, with Marconi a director in charge of all development work.

Being thus provided with funds for building more powerful apparatus Marconi, step-by-step, obtained greater and greater distances, flashing the first radio signals across the English Channel in 1899, and the first trans-Atlantic signaling (Glace Bay to England) in December, 1902. The accompanying publicity caused Leggett, an English writer, to state:

"The average English reader is practically unaware of the existence of any important commercial system of wireless telegraphy other than that of the Marconi Co., and is quite astounded when told of the existence of another system which, outside England and a few of its colonies, is perhaps for land stations the most extensively adopted by other countries."

The reading of this statement on the part of the administrative personnel of the Marconi Company was probably accompanied by cold chills down the backs of them, it probably having been in the way of news to them to learn that Marconi was not the only human being that knew of electrical communication without connecting wire. From then on, much effort was made to stage the name of Marconi in the plays that followed. This information probably prompted decision to extend into the United States by incorporating the Marconi Wireless Telegraph Company of America, and to file corresponding applications for patent in Marconi's name in the United States Patent Office.

As a promotional scheme the Marconi backers attempted to create for Marconi the appellation of "father of wireless telegraphy", and with the pressure brought to

UNITED STATES PATENT OFFICE.

MAHLON LOOMIS, OF WASHINGTON, DISTRICT OF COLUMBIA.

IMPROVEMENT IN TELEGRAPHING.

Specification forming part of Letters Patent No. 1,299,971, dated July 30, 1912.

To all whom it may concern:

Be it known that I, MAHLON LOOMIS, dentist, of Washington, District of Columbia, have invented or discovered a new and improved Mode of Telegraphing and of Generating Light, Heat, and Motive-Power; and I do hereby declare that the following is a full description thereof.

The nature of my invention or discovery consists, in general terms, of utilizing natural electricity and establishing an electrical current or circuit for telegraphic and other purposes without the aid of wires, artificial batteries, or cables to form such electrical circuit, and yet communicate from one continent of the globe to another.

To enable others skilled in electrical science to make use of my discovery, I will proceed to describe the arrangements and mode of operation.

As in dispensing with the double wire, (which was first used in telegraphing,) and making use of but one, substituting the earth instead of a wire to form one-half the circuit, so I now dispense with both wires, using the earth as one-half the circuit and the continuous electrical element far above the earth's surface for the other part of the circuit. I also dispense with all artificial batteries, but use the free electricity of the atmosphere, co-operating with that of the earth, to supply the electrical dynamic force or current for telegraphing and for other useful purposes, such as light, heat, and motive power.

As atmospheric electricity is found more and more abundant when moisture, clouds, heated currents of air, and other dissipating influences are left below and a greater altitude attained, my plan is to seek as high an elevation as practicable on the tops of high mountains, and thus penetrate or establish electrical connection

with the atmospheric stratum or ocean overlying local disturbances. Upon these mountaintops I erect suitable towers and apparatus to attract the electricity, or, in other words, to disturb the electrical equilibrium, and thus obtain a current of electricity, or shocks or pulsations, which traverse or disturb the positive electrical body of the atmosphere above and between two given points by communicating it to the negative electrical body in the earth below, to form the electrical circuit.

I deem it expedient to use an insulated wire or conductor as forming a part of the local apparatus and for conducting the electricity down to the foot of the mountain, or as far away as may be convenient for a telegraph-office, or to utilize it for other purposes.

I do not claim any new key-board nor any new alphabet or signals; I do not claim any new register or recording instrument; but

What I claim as my invention or discovery, and desire to secure by Letters Patent, is—

The utilization of natural electricity from elevated points by connecting the opposite polarity of the celestial and terrestrial bodies of electricity at different points by suitable conductors, and, for telegraphic purposes, relying upon the disturbance produced in the two electro-opposite bodies (of the earth and atmosphere) by an interruption of the continuity of one of the conductors from the electrical body being indicated upon its opposite or corresponding terminus, and thus producing a circuit or communication between the two without an artificial battery or the further use of wires or cables to connect the co-operating stations.

MAHLON LOOMIS.

Witnesses:
BOYD ELIOT,
C. C. WILSON.

Please Say That You Saw It in RADIO-CRAFT

bear publicly were successful until 1935 when this appellation was formally revoked, the story of which now follows.

Loftin. Having obtained an extensive education and experience in electricity, and particularly in electrical communications, commencing at the United States Naval Academy between 1904-1908, and post-graduate at Columbia University between 1913-1915 under the famous Professor Michael I. Pupin (who became "Mike" to me as one of a few), and in charge of electrical communications and developments from time to time, and most extensively in France during participation of the United States in the World War, I was appointed Chairman of the famous Interdepartmental Radio Board (2 Army, 2 Navy and 1 Justice members) to hear any and all claims against the United States for all of its uses of patented inventions in any and all radio equipment before and during the World War.

7777. The Marconi Company, having been quite successful with buying the appellation of "father of wireless telegraphy" for Marconi while having foreign and domestic courts sustain his No. 7777 first British patent and its corresponding United States patent, and its so-called "4 tuned circuit" patent, tried to use Marconi's "father of wireless telegraphy" name and his 2 patents as an Archimedes crowbar for prying open the doors of the vaults of the United States Treasury by suing the United States in the Court of Claims on July 26, 1916, for a named \$6,000,000.00. This suit was interrupted in 1919 by the Marconi Company presenting its claim to me on the Interdepartmental Radio Board in the hope of prying open the vault doors of the Treasury earlier than could be done by way of the Court of Claims. On account of muchly increased uses of radio by all Departments of the Government during the World War much more than \$6,000,000.00 was visioned.

With me never having seen a patent before, and Marconi Company so knowing, its representatives tried to make their crowbar appear big and strong by naming 350 patents as basis for its claim, this with other claimants naming in the order of 2,000 more. Before I finished with this company I learned that Marconi had not obtained during the preceding years as much as one patent over his original 2 in the 20 years of opportunity accorded him, and became suspicious of his creative ability because of this showing on his part. Nor were there any patents of the 350 that showed Marconi, as director in charge of development and research, had caused those under him to invent anything of use for radio communication, the company's representative having agreed with me to drop and forget 346 patents in the bunch. With my finally feeling them out as to a settlement for \$1,253,389.02, it was readily acknowledged to be acceptable, the Marconi Company being badly in need of money at the time.

Congress, on favorably listening to me about an appropriation of \$2,236,172.39 to settle all patent claims for radio use, listened to Congressman Blanton's objection on the grounds that the money should be spent for caring for our wounded soldiers instead of enriching the pockets of rich patent owners, and settlement died a quick death following 2½ years of hard and earnest labor.

Not long after the Attorney General wrote to the Secretary of the Navy saying that the Government, having been sued by the Marconi Company and others, and more suits were expected, was going to lose "many million dollars" if that fellow Loftin was allowed to go to sea where he

(Continued on following page)

Announcing...



THE NEW "HQ-120"

OUTSTANDING FEATURES

- Continuous range from 31 to .54 mc.—12 tubes.
- Antenna compensating control for maximum signal-to-noise ratio and image rejection.
- 310 degrees band-spread on all amateur bands.
- Noise limiter follows A.V.C. for quiet reception.
- Variable band width crystal filter for phone reception.
- Calibrated "S" meter on all models.

THE Hammarlund "HQ-120," short wave receiver, is designed for both amateur and short wave listener. The "HQ-120" is a thoroughly new receiver. Hammarlund's engineers have developed a new and outstanding crystal filter circuit. This crystal filter, which is included in the "HQ-120," can be used for voice or music, as well as for code reception. The short wave listener can now enjoy the same benefits of a crystal filter that hams have enjoyed for many years. The adjustable selectivity range of the crystal filter in the "HQ-120" is so flexible that it can be used even in the regular broadcast band. Special tuning condenser design results in 310 degrees spread in each amateur band. This wide band spread feature works continuously throughout the high frequency range of the receiver.

In order to permit a wide selection of antennas, the "HQ-120" has an antenna compensating control providing maximum gain and highest signal-to-noise ratio for various types of antennas. Other outstanding features are: Noise limiter, for those troubled with automobile ignition interference and similar disturbances; 3 stages of I.F.; one very effective R.F. stage with high selectivity and gain, due to special antenna compensator; signal strength meter; A.V.C.; voltage regulated power supply; beat oscillator; phone jack; relay connection, and many others. Ask your jobber for a demonstration!

Send for free 16-page booklet, C-1.



HAMMARLUND MFG. CO., INC.
424-438 WEST 33rd ST., NEW YORK
CANADIAN OFFICE: 41 WEST AVE., NO., HAMILTON, ONT.



Be sure to read the NEW POLICY ADVERTISEMENT which appears on Page 444 of this issue. Turn to it NOW!

ELECTRICALLY RECORDED RECORDS



SAVE MONEY ON ALL BRANDS OF PHONOGRAPH RECORDS

We have an exceptionally large variety of standard records (play both sides) played by popular artists. Records of hot dance numbers, vocal, waltzes, instrumental, old-timers, hill-billy, etc., are available. **WRITE TODAY FOR RECORD CATALOG.**

FREE GIANT RADIO CATALOG for Dealers. Service Men and Experimenters is NOW READY! Send postcard today for yours.

UNITED RADIO COMPANY
Dept. R-1000, Newark, N. J.

THE NEW EASY WAY TO LEARN CODE

and to Learn It Right



Now you can master code easily, quickly and inexpensively by listening to phonograph records keyed by an expert and especially designed for home study by amateurs and experimenters.

RALSTON RECORDED CODE COURSE

You hear the signals exactly as they sound over the air. Everything is explained in detail, both in the recordings and the accompanying book of instructions—you develop speed and confidence with amazing rapidity. Investigate today.

Save time—save unnecessary work—save money. Learn code the modern way!
RALSTON RECORD CO., 5433-R Willows Ave. Philadelphia, Pa.

Please Say That You Saw It in RADIO-CRAFT

YOUR LAST CHANCE!

★ DUES WILL BE INCREASED JANUARY 1, 1939
 ★ \$1.00 of 1938 dues will be credited on 1939 dues
 if you join before Jan. 1, 1939

MAIL THIS COUPON!

RADIO SERVICEMEN OF AMERICA, INC.
 304 South Dearborn St., Chicago, Ill.

Gentlemen:
 I hereby make application for membership in the
 Radio Servicemen of America.

Name _____ State _____
 Home Address _____
 City _____
 Firm Name _____
 Address _____

I am enclosing \$2.00 National Yearly Dues, (Nominal Local Chapter Dues
 not included.)

The Best \$2.00
 You Ever Invested.

RADIO SERVICEMEN OF AMERICA, INC.
 Joe Marty, Jr., Executive Sec'y
 304 S. Dearborn St., Chicago

RSA has pioneered and established these benefits for you. Join now — so you can get them: ★ Membership in the only Independent Servicemen's Organization in the Industry. ★ Advanced Service Courses for Members. ★ Technical advice and assistance for members asking it. ★ Recognition by and representation in the entire servicing business. ★ RSA is as important to you as your job or your business. Don't wait—send your application in **today!**

MARCONI—FATHER OF RADIO?

(Continued from preceding page)

belonged because he was told by his patent fellows that Loftin was the only one that could save the situation, and though he knew he was butting into the Navy Department's affairs, he couldn't help doing so, and the said Loftin's orders to sea were cancelled.

The Marconi Company then employed a number of so-called experts, as well as Marconi himself, to work with its crowbar by way of the Court of Claims, and this crowd pumped 1,154 pages of testimony and 367 exhibits on the crowbar as lubrication for its job, and I wiped it all away with 346 pages of my testimony.

Court Decision. On November 8, 1935, government counsel in the case wrote me that the Court of Claims had decided against Marconi in exactly the way I advised it to do, and my testimony had wiped out the entire claim in effect, and the Department of Justice would furnish me with a copy of an 80-page printed decision it used in following my testimony, and I would find it "especially gratifying" because my testimony did the job. On page 52 of this decision the Court of Claims said unanimously:

"Guglielmo Marconi, an Italian scientist, is sometimes called the father of wireless telegraphy but he was not the first to discover that electrical communications could be made without the use of connecting wire."

At last the truth is confirmed. Marconi possessed commercial initiative instead of creative genius, and dissipation of the smoke screen has brought this to light.

This put an end to the Marconi interests attempting to pry open the doors of the Treasury vaults, and they had to depend upon the pocket of the Radio Corporation of America, which has stepped into Marconi's shoes in the United States, to pay the wasted costs of the crowbar action, it having been found that the crowbar had reached its elastic limit, and cracked under the pressure exerted on Treasury vault doors.

Some people recently became interested in erecting in Washington a memorial to Marconi as inventor of wireless telegraphy, and in the name of The Marconi Memorial Foundation, Inc., asked Congress for permission to do so with the result that permission was granted in Public Resolution No. 86, 75th Congress, approved by the President April 13, 1938. I ask who is capable of composing an epitaph for such a memorial that will not conflict with the holding of the august body comprising the Court of Claims of the United States decided in Marconi vs. The United States, November 4, 1935?

(COPY)

Edwards, Bower & Pool
 Counsellors at Law
 63 Wall Street
 New York

November 8, 1935.

Mr. Edward H. Loftin,
 1406 G Street, N. W.,
 Washington, D. C.

Dear Mr. Loftin:

Marconi v. U. S.

I received this morning a copy of the opinion of the Court of Claims in the above

case. Mr. Mothershead will send you a copy. When you receive it you will note that it wipes out the entire claim except for the small use of the Lodge loading coil between March 8, 1913, and August 16, 1915, and the relatively insignificant use of some sets employing a variable condenser in addition to the usual variable inductance in the antenna.

I think the decision will be especially gratifying to you because on all vital questions concerning the operation of the apparatus and the scientific questions involved, your testimony has been adopted. I stated to you sometime ago that in preparing the brief in the case I was especially impressed with the clarity and thoroughness of your testimony, and I think that the successful outcome is in large measure due to your testimony.

With best regards, I am

Yours very truly,

(s) C. V. EDWARDS.

NOTE: The writer, in the capacity of Special Assistant to the Attorney General, was Government Counsel in this case, the defense of which was worked up by the addressee. This case was one with which the Attorney General in his letter of August 2, 1922, was most concerned. Marconi's testimony, including Marconi in person and 5 technical witnesses, aggregated 1,154 printed pages and 367 exhibits, answered by 345 pages of corroborative testimony and 185 exhibits. Decision covered 80 printed pages. The claim is, in effect, completely wiped out, as the cost to Marconi of establishing amount of Government use would exceed what could finally be recovered. The last page of record in the case is the Govern-

Please Say That You Saw It in RADIO-CRAFT

ment's brief numbered 4,289. This suit ran 19 years before completion.

(COPY)

OFFICIAL U. S. NAVAL RECORD OF EDWARD H. LOFTIN, LIEUTENANT-COMMANDER UNITED STATES NAVY, RESIGNED.

OFFICE OF THE ATTORNEY GENERAL August 2, 1922.

Honorable Edwin Denby, Secretary of the Navy, Washington, D. C.

Dear Mr. Secretary:

This Department is engaged in the preparation for the defense of a number of suits brought by the Marconi Company and others against the United States on various patents relating to radio communications. These, with claims being investigated which may result in suits, involve the charge of responsibility by the United States to the extent of many millions of dollars.

It will be necessary for the proper presentation of the Government's defense in these cases to have the assistance of the experts of your Department and particularly the patent branch of this Department has been depending upon the assistance of Lieutenant-Commander E. H. Loftin, U.S.N., in the patent section of the Radio Division of the Bureau of Engineering, Navy Department. Lieutenant-Commander is represented to me as the one person best fitted in your Department to give efficient aid in the defense of the United States in these important suits by reason of his extensive acquaintance with Government practice in the radio art and his experience as chairman of the Interdepartmental Radio Board. My assistants who have charge of these matters report to me that they are greatly concerned to learn that Commander Loftin will be ordered to sea and be unavailable when needed.

I trust that you will not consider that I am interfering with the management of your Department if I say frankly that I consider the absence of Commander Loftin during the next year may result in very considerable loss to the Government in these suits and I would deem it a special favor if you would take steps as to insure his presence here so that he may be on call of this Department in connection therewith.

Respectfully,

(s) H. M. DAUGHTERTY, Attorney General.

NOTE:

The "many millions of dollars" and "very considerable loss" was estimated by those acquainted with the situation to be of the order of 40 million dollars (\$40,000,000.00) with Marconi as principal claimant. The one named has finished all of these suits, 12 in number, with the loss not exceeding 1/2-million dollars.

[PUBLIC RESOLUTION—No. 86—75TH CONGRESS]

[CHAPTER 147—3D SESSION]

[H. J. Res. 499]

JOINT RESOLUTION

Authorizing the erection of a memorial to the late Guglielmo Marconi.

Resolved by the Senate and House of Representatives of the United States of America in Congress assembled, That the Secretary of the Interior be, and he is hereby, authorized and directed to grant permission to The Marconi Memorial Foundation, Inc., for the erection on public grounds of the United States in the District of Columbia, other than those of the Capitol, the Library of Congress, and the White House, of a memorial of simple and artistic form to the late Guglielmo Marconi, inventor of an apparatus for wireless telegraphy, by the American people: Provided, That the site chosen and the design (Continued on following page)

Don't Take Our Word For It!

SERVICEMEN SAY THE FASTEST METHOD OF TROUBLE SHOOTING IS WITH



Net \$107.50

The RIDER Chanalyst

COATESVILLE, PA.

"It's the easiest thing to use in my shop . . . does away with all guesswork and speeds up our service work. . . I put it to work as soon as I got it and have been using it every day since, on large and small jobs."—M. Godschild.

PADUCAH, KY.

"I have had better results with the Electronic Voltmeter (in the Chanalyst) than any other output indicator I have tried. I have found the Chanalyst very useful checking intermediate frequency and in finding troubles which would have been hard to find otherwise, such as intermediate transformers that show resistance on the Ohmmeter but are still bad."—Emmet Helm.

HAZLETON, PA.

"I now find it indispensable . . . The Chanalyst enables you to actually travel through a receiver, everything seems to open up before you."—Residential Radio Sales and Service.

DRYDEN, N. Y.

"The Watt Indicator in the Chanalyst, alone, saved me a lot of trouble and time on three sets where the power transformer had been subjected to a heavy overload and was burnt bad. The Chanalyst takes all the GUESS WORK out of servicing."—E. M. Little.



JOHN F. RIDER

in whose Successful Servicing Laboratories this revolutionary instrument was developed.

Get a DEMONSTRATION Today!

SERVICE INSTRUMENTS, INC.

404 FOURTH AVENUE NEW YORK CITY

OVER THIRTY-FIVE BIG OFFERS!

The Classified Section which appears on Pages 438 and 439 contains many interesting offers and services. TURN TO IT NOW . . . READ IT FROM START TO FINISH!

SOLAR
MINICAP
Newest development in Electrolytic Capacitors
Catalog upon request
SOLAR MFG. CORP. 599-601 Broadway, New York

BRUSH
HIGH LEVELER SERIES MICROPHONES
Range in price from \$22.50 to \$32.50. New Brush headphones.
Write for your Brush catalog today.
THE BRUSH DEVELOPMENT COMPANY
3312 PERKINS AVENUE CLEVELAND, OHIO

Please Say That You Saw It in RADIO-CRAFT

SPRAGUE ATOMS

"Mightiest Midgets of All"

- ★ DUAL COMBINATIONS OR SINGLES
- ★ SMALLEST SIZES ON THE MARKET
- ★ ALL WORKING VOLTAGES
- ★ UNCONDITIONALLY GUARANTEED AGAINST BLOWUPS
- ★ LOW LEAKAGE PREVENTS OVERHEATING
- ★ QUICK BUILD-UP—HIGH SURGE VOLTAGE—FOOL-PROOF

IN BRIEF... recommended universally for replacements... especially where space is at a premium or where you need a really reliable condenser at a ROCK BOTTOM PRICE.

A typical ATOM value—8-8 mfd. 450 volt 1" diam. 2 3/4" long, list only \$1.00
Note common negative lead.



SPRAGUE
450 VOLTS
SPRAGUE PRODUCTS CO.
North Adams, Mass.

Size of box: 12 1/2" x 8 1/2"



\$2.75

Shipping Wt. 3 lbs.

Pyro Pantagraph

VOGUE

With this PYRO PANTAGRAPH turn leisure time into profitable hours. Make money a novel, easy way—"Burn Your Way to Extra Dollars with Pyro Pantagraph." This electrical outfit is especially designed for burning designs permanently on Leather, Wood, Cork, Gouris, Bakelite, etc. Simply plug the Pyro-electric pencil in any 110-volt AC or DC outlet and it is ready to be used. Plug and cord furnished as part of equipment.

By the use of a special Pantagraph included in the outfit, any design may be reproduced either in original, reduced or enlarged form.

Outfit consists of: one Pyro-electric Pencil; one Pantagraph; three hardwood plates; one bottle of Varnish; one Brush; one tracing tip and four-page instruction sheet.

Outfit will be forwarded by Express Collect if not sufficient postage included with your order.

WELLWORTH TRADING COMPANY
558 W. WASHINGTON BLVD., Dept. RC-139, Chicago, Ill.

NEW RADIO ALTIMETER INCREASES AIR SAFETY

(Continued from page 395)

sound had to travel just that much further before the echo could be observed. a "lag meter" indicating this degree of lag—or difference between radiated and received frequencies—could be calibrated to read directly in feet distance. This "lag" may be compared to the "beat" mentioned in the 1st example; the beat frequency (lag) therefore is a direct indication of the echo distance.

This becomes quite clear upon observing that, when note No. 5 is radiated and note No. 2 is being received, THERE IS STILL A DIFFERENCE OF 4 NOTES; that is, the echo distance has not changed, hence, the feet-distance (beat frequency) indication remains unchanged.

Applying this crude simile to the radio altimeter, let us consider that the 500-megacycle signal is "wobbled" or frequency modulated. That is, shifted up and down the radio frequency (wavelength) scale, smoothly and continuously.

The various beat frequencies then required to indicate equivalent echo distances (or, in the instance of airplane operation, altitude above ground, or a bridge, a building, or any other reflecting surface) are as given in Table I. The figures are from patents issued to Lloyd Espenschied and assigned to American Tel. & Tel. Co.

Height of Aircraft	Frequency Interval (Cycles) of "Beat"
Above Ground	5,000,000
30 meters (about 100 ft.)	1,500,000
100 meters (about 300 ft.)	500,000
300 meters (about 1,000 ft.)	150,000
1,000 meters (about 3,000 ft.)	50,000
3,000 meters (about 10,000 ft.)	

With this introduction we are prepared to consider a graph, Fig. 2, which has been made available by Western Electric Co. This figure illustrates the basic principle of reflecting a frequency-modulated radio wave (the speed of which is constant) and indicating the elapsed time as proportional distance.

If an airplane is equipped with a radio oscillator whose frequency can be "wobbled" according to the sawtooth curve a1 b1 c1 of Fig. 2, and if a corresponding wave is radiated toward the ground, some of the energy will be reflected back to the plane where it will set up a current in an antenna. The frequency of that current will have a similar wobble, but displaced in time to the position a2 b2 c2 by reason of the delay in travel to the ground and back. At any instant the frequency of the received wave will differ from that sent out by a constant amount equal to p1 p2.

If the ground falls away or the plane rises, the travel time will be increased and the received current will be displaced still further; consequently, the frequency difference at any instant will increase in proportion to the change in clearance.

The difference in frequency between 2 currents can be measured by passing them through a modulator tube, and measuring the frequency of the "difference" component in a frequency meter. The scale of this instrument is then graduated in feet, and indicates directly the terrain clearance.

TRANSMITTER AND RECEIVER

Some idea of how microwave signals may be generated and frequency-modulated at the transmitter, and the reflected and "slop-over" signals received and the beat frequency detected and made to indicate on a meter calibrated in altitude at the receiver, may be obtained by reference to Fig. 3. These illustrations are based in part on figures in an article, by Sadahiro Matsuo

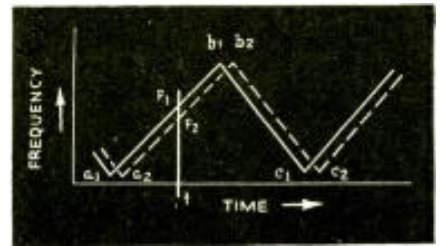

Fig. 2. The frequency-modulated signal is reflected.

(Faculty of Engineering, Tohoku Imperial University, Sendaishi, Japan), on a radio altimeter, in a recent issue of *Proc., I.R.E.*

Referring to Fig. 3A the sawtooth-wave-form modulation, shown in Fig. 2, is obtained from modulator V2 and applied in required degree to the grid of V1, (NOTE—Matsuo's transmitter employed V1 as a Barkhausen-Kurtz triode oscillator.—Author)

In Fig. 3B, the beat-frequency signal is detected, amplified, limited to a constant value, and applied to an output meter (altitude indicator). In order to secure satisfactory operation of an indicator-type frequency meter, with a constant-output-level beat frequency input, inverse voltage is fed to tubes V4-V5 by connecting transformer secondaries Sec. 1 and Sec. 2 as shown. Tubes V4-V5 alternate in conductivity.

In addition to the regular meter, the device may also be equipped with a red signal light which will automatically flash a warning when the plane descends below a safe predetermined altitude.

This radio distance indicator may also be used on shipboard. In foggy weather the presence of icebergs, other ships, promontories, etc., could be detected and their exact distance indicated.

In commenting on this latest scientific tool for aeronautical navigation, W. A. Patterson, President of United Air Lines, said, "Our engineers and pilots regard the development of this device as one of the most important technical advancements in the history of air transportation, and a major contribution to the safety of scheduled flying. Following completion of service tests now in progress with the device in United's Flying Laboratory, we will make these devices standard equipment on every airliner in our fleet."

MARCONI—FATHER OF RADIO?

(Continued from preceding page)

of the memorial shall have the approval of the National Commission of Fine Arts and that the United States shall be put to no expense in or by the erection of the said memorial: *Provided further*, That unless funds, which in the estimation of the Secretary of the Interior are sufficient to insure the completion of the memorial, are certified available, and the erection of this memorial begun within 5 years from and after the passage of this legislation, the authorization hereby granted is revoked.

Approved, April 13, 1938.

EDITORIAL NOTE—The photo on pg-393 illustrates Commander Loftin (at present director and patent attorney of International Television Radio Corp.) in uniform at the time he gave evidence before the committee of the Interstate Commerce Commission that resulted in his report in the form of "Radio Industry" dated 1923. He introduced the famous Loftin-White direct-coupled amplifier.

Please Say That You Saw It in RADIO-CRAFT

MAKE THIS PLUG-TOGETHER 8-TUBE A.C. RECEIVER

(Continued from page 401)

evident is the ease with which changes or additions can be made. If more power is desired, a larger supply can be made incorporating output tubes to be driven by the output of the existing A.F. chassis. If more A.F. gain is needed for some low-level input, a preamplifier can be inserted between the A.F. and I.F. chassis. If high fidelity is needed, transformers can be easily changed. For the amateur, hand-spread and noise-silencer circuits can be conveniently added at any time. Or for those interested in the ultimate of broadcast reception, volume expansion and A.F.C. circuits can also be taken care of. It is therefore a good idea, if additions are anticipated, to provide the initial set with more than an ample power supply. Then the set can grow safely in all directions.

The chassis for the units described are so small that they can be shaped by almost anyone and require but small pieces of metal such as are likely to be found in most junk boxes. As can be seen, the circuit is quite conventional in most details, the merit of the system lying in its method of construction and consequent availability of full performance from each unit.

LIST OF PARTS

Tubes & Sockets

- One RCA type 6A8;
- One RCA type 6F5;
- One RCA type 6F6;
- One RCA type 6H6;
- Three RCA type 6K7;
- One RCA type 6U5;
- Eight wafer-type octal sockets;
- One plug-type 6-prong socket.

Resistors

- One I.R.C., 270 ohms, 2 W.;
- Two I.R.C., 300 ohms, 1/2-W.;
- Three I.R.C. 2,000 ohms, 1/2-W.;
- Two I.R.C., 5,000 ohms, 1/2-W.;
- Two I.R.C., 30,000 ohms, 1/2-W.;

- One I.R.C., 50,000 ohms, 1/2-W.;
- Three I.R.C., 0.1-meg., 1/2-W.;
- One I.R.C., 0.25-meg., 1/2-W.;
- One I.R.C., 0.5-meg., 1/2-W.;
- One Centralab potentiometer, 0.5-meg.;
- Two I.R.C., 1 meg., 1/2-W.

Condensers

- One Cornell-Dubilier 65 mmf. mica;
- One Cornell-Dubilier 100 mmf. mica;
- One Cornell-Dubilier 0.005-mf., 200 V. tubular;
- One Cornell-Dubilier 0.005-mf., 600 V. tubular;
- Five Cornell-Dubilier 0.02-mf., 200 V. tubular;
- Four Cornell-Dubilier 0.05-mf., 200 V. tubular;
- One Cornell-Dubilier 0.05-mf., 400 V. tubular;
- One Cornell-Dubilier 0.1-mf., 200 V. tubular;
- Four Cornell-Dubilier 0.1-mf., 400 V. tubular;
- Two Cornell-Dubilier, 8 mf., 450 V., dry electrolytic;
- One Cornell-Dubilier, 10 mf., 25 V. dry electrolytic.

Miscellaneous

- One matched set—ant., R.F. and osc. coils;
- Three Sickles I.F. coils, No. 829;
- One choke, 10 hy., 50 ma.;
- One Cinaudagraph 6-in. speaker with 6F6 output transformer;
- One power transformer, 700-700 V. sec. at 50 ma., 6.3 V. A.C. at 3 A.;
- One S.P.S.T. toggle switch;
- One S.P.S.T. rotary switch;
- One 365 mmf. 3-gang condenser with 456 kc. tracking section;
- One dial;
- One planetary drive unit;
- Three male chassis plugs, 7 prongs;
- Three female chassis plugs, 7 prongs;
- One 5-prong speaker plug and socket;
- Four chassis assemblies, furnished on order by "X" Radio Lab.

NEW CIRCUITS IN MODERN RADIO RECEIVERS

(Continued from page 410)

(4) ELECTRONIC SILENT TUNING SYSTEM FOR MOTOR DIAL

General Electric Model G-106. A silent tuning system having no moving parts and depending on no contacts is used in this circuit.

One terminal of the motor as in Fig. 2A is connected to the cathode of one section of the 6H6 2nd-detector. This terminal will be supplied either directly or through the 60 mf. condenser with the supply voltage to operate the motor, it being approximately the same for either position 1 or 2 of the motor reversing switch.

The cathode is supplied with 60 cycle A.C. and when driven only a few volts negative, diode current will flow through R26. Practically all of the voltage drop to the cathode potential will be across this resistor, and it will charge condenser C56 to practically the cathode peak value—negative with respect to ground. There being no constant current flow through R27, the grid of the 6F5 will also drop to this value, which is considerably beyond its plate current cut-off value. When the motor circuit again opens, the cathode returns to ground potential, which is 2 volts more positive than the plate of the 6H6 muter section and no diode current can flow. When this occurs, R26 simply acts as a series resistor in the 6F5 bias circuit as R27, neither having any voltage drop across them.

(5) TONAL EXPRESSION IN FIXED STEPS

Zenith Model Radiorgan. Six separate circuits are provided to make definite independent alterations of amplitude in the audio spectrum. With these 6 individual switches designed as organ stops, 64 different combinations of tone may be obtained. Each stop, which controls its own switch has an independent effect on the circuit, and definite sections of the spectrum are controlled by each button. The electrical effect is similar to the acoustical effect produced by a regular pipe organ.

The circuit, Fig. 2B, shows the 6 switch connections in the 1st and 2nd A.F. circuits. C1 and C2 are of the series signal type, that is the signal is transmitted through them for use instead of being bypassed to ground as loss. The others are of the shunt type. They have exactly opposite effects on the amplifier characteristics. For example, C1 as shown will transmit the very high audio frequencies, while if it were a shunt type, it would tend to eliminate them.

The condensers are identified in their effect on the circuit as follows: C1—Treble; C2—Normal; C3—Voice; C4—Alto; C5—Bass; C6—Low Bass. Condensers C3 and C4 provide different ranges of compensation in the first A.F. grid while C5 does the same for the 2nd audio grid. Condenser C6 is an ordinary bypass unit, while C1 and C2 transmit different portions of the treble audio frequency scale.



Get this book of **RADIO VALUES** NOW!

Complete, Authoritative, Unequaled Values!

FREE

SEND COUPON FOR ALLIED'S 1939 CATALOG

62 NEW Knight RADIOS

Models for every purse and purpose, with new advanced features, at low prices! 4 to 16 tubes—new "Tiny Knights," 1 1/2 Volt Battery sets, new AC, AC-DC, 6 Volt, 3 1/2 Volt and auto models. Also, Radio's biggest selection of phono-radios, phonographs, record players—priced for greater savings and profits for you! You'll profit more and save more with the new Knight Radios. More power, greater beauty, finer tone quality—a line packed with sales appeal! Send for ALLIED's Catalog today!

Save money on **EVERYTHING IN RADIO**

Servicemen! See the newest testing equipment, to make your servicing easier and more profitable. New Push-Button replacement parts! 14,000 Amateur! Lowest prices on the new National NC-44 and "5-10" Howard 450, 440 and 430 receivers; also all the newest transmitters. P.A. Specialists! Revolutionary new Knight Sound Systems from 8 to 65 watts. Standard and deluxe jobs.

Free! BUILDER'S PARTS LIST

ALLIED's new Catalog is the Radio Builders' "Dream Book." It includes dozens of "Build-Your-Own" kits and diagrams and projects for building 100 more. Write for Free Parts Lists for any kit described in this or any other magazine.

It's a fact!

In 1937 ALLIED sold over 300,000 radio tubes of all types and makes—laid end to end, they would span the famous San Francisco-Oakland Bay Bridge 5 times. That's an awful lot of 'em—and we do mean tubes!

ALLIED RADIO

ALLIED Radio Corp., Dept. 2-A-9, 833 W. Jackson Blvd., Chicago, Ill.

Send me your Free 1939 Catalog.

Name

Address

Please Say That You Saw It in RADIO-CRAFT

QUALITY—VALUE—GUARANTEE!

WESTINGHOUSE POWER GENERATOR

Manufactured for U. S. Signal Corps

A. C. ELECTRICAL POWER
 from a Windmill, from available Waterpower, from your Automobile, from your Motorcycle, from your Bicycle, Footpedals or Handcrank (for transportable Radio Transmitters, Strong Floodlights, Advertising Signs); operate two generators in series to get 200 V. AC; obtain two phase and three phase AC, etc., etc.

There Are Over 25 Applications
 Some of which are:

A.C. Dynamo lighting from eight to ten 20 Watt 110 Volt lamps. Short Wave transmitter supplying 110 Volt AC for operating "flam" transmitter on motor boats, Public Address Systems, Electric Signs on "fever" yachts, etc. Camp Lighting, Short Wave artificial lighting apparatus, Television, Pelton Waterwheel for lighting other purposes, Airplane for lighting strong search lights or electric signs, Laboratory work, etc., etc.
 1/4 to 1/2 H.P. needed to run generator.
 Generator, as described, including BLU. PRINT 22 x 28 in. and Four-Page 8 1/2 x 12 in. INSTRUCTION SHEETS **\$7.90**
 Send \$2.00 deposit, balance C.O.D. Shipping weight 18 lbs.



200 Watt.
100 V. AC

WESTINGHOUSE UNIVERSAL MOTOR

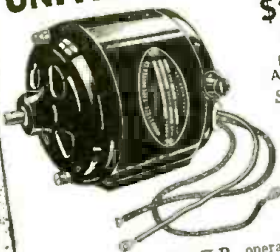

\$2.55

110 Volts AC and DC
Shipping Weight 3 lbs.

Specifications: 1/30 H.P. operates on either A.C. or D.C., 110 volts, 5000 R.P.M., Rheostat can be used to vary speed. Height 3 3/4" Length 3 3/4" Width 1 1/4" Shaft 1/8" one inch long. Can be used to drive Sewing Machines, Models, Burling Lathes, Polishing Head, Drills, Grindstones, etc., etc.

MOTOR only **\$2.55**
 MOTOR with Arbor and 1/4" Chuck. **\$3.55**
 Add 25c for special packing and mailing anywhere in U. S. A.

G. E. PHONOGRAPH MOTOR

Formerly Sold for \$15.00

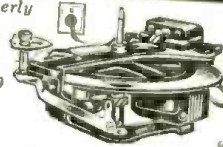

\$4.95

Variable speed induction type self-starting. 110 volt, 25 to 60 cycle. A.C. with speed control, plug and cord. Speed range from 5 to 200 R.P.M. Can be installed in place of old-fashioned, hand-winding speed motor. Also ideal for display turn table, and a hundred other uses. These General Electric Motors have never been used and come four packed in original carton. G. E. Electric Phonograph motor as described (with out turntable) **\$4.95**

Shipping Weight—12 lbs.

ALL OUR MERCHANDISE IS UNUSED AND SOLD ON A MONEY-BACK GUARANTEE

MICROPHONE AND RECEIVER

This Microphone and telephone headset outfit was built especially for the U. S. Navy Aviation Corps. The Holzer-Cabot Electric Company constructed the outfit to Government specifications. The outfit consists of a low-impedance carbon microphone (transmitter), securely fastened to a metal breastplate, and a set of heavy-duty, low-switch on the back of the breast-plate controls the microphone circuit. The earphones are U.S.N. Twenty-eight feet of very heavy weather and waterproof conductor cable is furnished, and of not more than 10 volts should be used. A storage battery is the most satisfactory current supply.

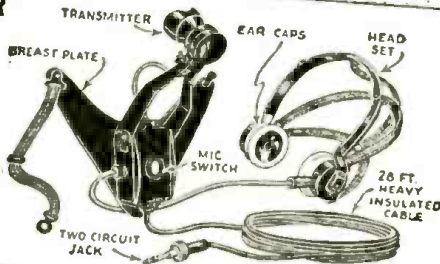

U. S. Navy Airplane-type Microphone and Receiver as described **\$4.96**
 Shipping Weight—9 lbs.

WELLWORTH TRADING CO.

Dept. RC-139
 560 W. WASHINGTON BLVD., CHICAGO, ILL.

★ ORDER DIRECTLY FROM THIS ADVERTISEMENT ★
 WE SHIP 24 HOURS AFTER RECEIPT OF YOUR ORDER, BY EXPRESS COLLECT OR PARCEL POST IF YOU INCLUDE SUFFICIENT POSTAGE.

YOUR LAST OPPORTUNITY TO GET THIS FREE BOOK!

Only a few copies of the 1938 RADIO REFERENCE ANNUAL are still available! It's the BIG, FREE BOOK of 64-pages you receive when you subscribe to RADIO-CRAFT. The ANNUAL covers set building, servicing, public address, test equipment, plus a number of other interesting topics. Send your remittance of One Dollar to RADIO-CRAFT, 99-R HUDSON STREET, NEW YORK, N. Y., and you will receive a subscription to RADIO-CRAFT for Seven Months, and your copy of the 1938 RADIO REFERENCE ANNUAL will be mailed postpaid immediately.

It's Your Job Today to prepare for a better radio job tomorrow!

You need something more than just "good intentions" to get ahead in Radio. Today's opportunities go to the men with TECHNICAL TRAINING. Our "Tested Plan for a Future in Radio" tells how YOU can improve your position. Write for your FREE COPY right now to—
CAPITOL RADIO ENGINEERING INSTITUTE
 Dept. RCI 3224-16th St., N.W. Washington, D. C.



EVERYTHING IN RADIO!

A COMPLETE SOURCE FOR YOUR RADIO NEEDS
 Our immense stock of radio sets, parts and supplies enables you to purchase your entire needs on one order. You will find all your Nationally Known Favorites in this big book which is FREE for the asking. Practically every order is shipped the same day it is received.
 WRITE FOR BIG NEW CATALOG

BURSTEIN-APPLEBEE CO.
 1012-14 McGee St. + Kansas City, Mo.

THE PROPOSED TELEVISION STANDARDS —ARE THEY FAIR TO ALL?

(Continued from page 403)

broadcasting frequencies, and for the following reason.

Radio broadcasting is a powerful medium for sales, and why should it not be employed to interest radio set owners in television? Of course the initial programs must have both sight and sound interest. Furthermore, the employment of the sound broadcast band will save the general public dollars on their initial outlay for television, and this fact alone is highly important.

I do not take the position that all standardization ideas are bad, but I am equally certain that such proposals must be so broad in every case that they will encompass every hopeful television system that now exists, or may yet exist.

Standards such as a definition of the radio channels are essential, and have already been adopted. Standards defining a minimum quality in terms of a minimum number of televised segments a second, are desirable. But detailed standards—that by application and implication serve to fasten a device upon this art a system that in the very nature of it is expensive, produces an inadequately-sized image, employs dangerous potentials, and is fragile and uncertain in life—are a vicious answer that cannot endure.

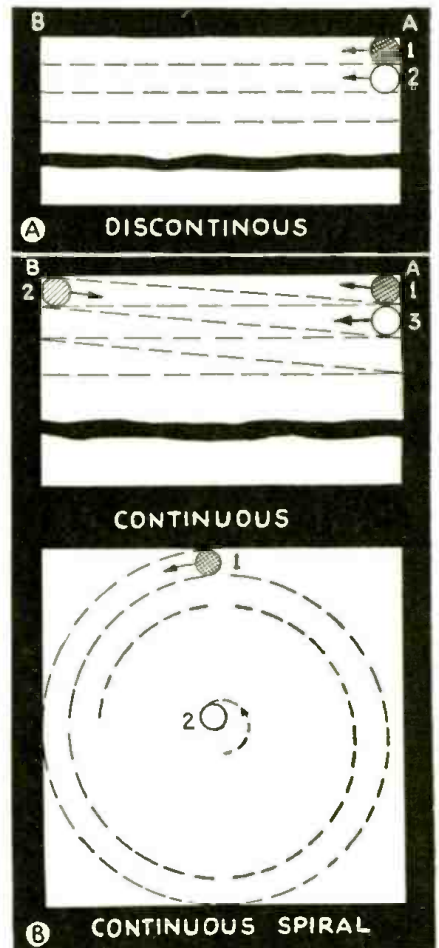

Fig. 3. In A, spot 1 moves from A to B and is extinguished. It reappears as spot 2 on A and moves to B and is again extinguished. In B, "parallel" continuous scanning, spot 1 moves from A to B, appears as spot 2 and then moves to A appearing as spot 3, and continues to repeat. In "spiral" continuous scanning, spot 1 moves in a continuous spiral to spot 2 position and returns on its former track to spot 1 (or on its inverted track to spot 1).

Please Say That You Saw It in RADIO-CRAFT

THE DYNATONE PHONO-RADIO-ELECTRONIC PIANO

(Continued from page 398)

operating through the same amplifier system; a soft harpsichord tone that is ideal for practice is secured.

The cabinet is of strikingly original design, about the size of the popular small pianos (3 ft. high x 2 ft. deep x 4½ ft. wide, approx.). The appearance, however, is quite different, being more suggestive of a small organ console. (See Fig. A.) Below the keyboard on the left-hand side is a drawer housing the phonograph turntable and pickup. Behind a door on the right-hand side in the corresponding position are the radio controls (tuning and wave-change knobs). The keyboard has the full 88 notes of the large pianos. In spite of the small size of the DynaTone, which makes it practical for use in the average-size home, the tone and volume are not those of a small piano, but of a 6-foot grand. The tone of the radio and phonograph are comparable only with the finest large combinations.

The electric amplifier is the heart of the instrument and the complete unit has been designed around this. (See diagram.) The amplifier has been designed for the most uniform possible response over the entire musical range. Triodes have been used throughout to keep the harmonic distortion to the absolute minimum. There are 4 stages of amplification; the final stage consisting of type 2A3 tubes in push-pull, having an output of 15 W. To fully utilize the tone-quality and output of this amplifier, a massive high-fidelity speaker is used.

The amplifier and power supply have felt strips between all metal parts that could possibly cause vibration (rattles).

The cabinet also has been designed and built to meet this special requirement. In the hollow compartments forming the columns at either end of the DynaTone case, are located the amplifier and power supply. The amplifier is in the left-hand side, and the power supply in the right. The loudspeaker is mounted behind the grille on the right-hand side of the lower panel. Additional grilles are provided in the two side compartments to give ventilation to the electric equipment.

ELECTROSTATIC PICKUP

The piano action, pedals and strings are conventional so that the "feel" of the keyboard is exactly the same as that of a standard large piano. There is, however, no sounding board since the tones are picked up electrically from the vibrating strings, amplified and reproduced through the loudspeaker. (See "Latest Tone-Controlled Electronic Piano," January, 1938, *Radio-Craft*.—Editor)

The conventional piano bridge is retained, but instead of being mounted on a sounding board is supported only on a skeleton structure of ribs. On top of this bridge is a bakelite strip carrying the electrostatic pickups; a separate one of which is used for each string. Each of these pickups consists of a screw with a polished brass head which is brought close to the string, but not close enough so that the string will touch when it vibrates. The pickup screws are all connected in parallel by means of a brass strip against which a lock nut on each screw is tightened.

Electrically, the piano strings, together with the cast-iron plate which supports them, are at ground potential. The pickup screws are insulated and are connected to a high positive voltage.

Each pickup screw is individually adjustable (see insert in Fig. B) and, since the output increases as the screw is brought closer to the string, it is possible to make

up for the usual inequalities of the piano scale (as compared to the usual methods of tone regulation on the piano action).

The impedance of this input circuit between the pickup screws and the amplifier must be kept high (a 5 megohm resistor is used), and because of this high impedance and the high gain of the amplifier, the entire instrument must be completely shielded. This shielding is obtained by lining the entire DynaTone case with metal foil, which is carefully connected together at the joints. (See Fig. B.)

PHONO-RADIO

The turntable motor has been selected because of its quietness and excellent speed regulation. The phonograph pickup is of the crystal type, with a curved arm for better tracking. The phonograph pickup is mounted in rubber to insulate it from any cabinet and motor vibration. (If an automatic record changer is required, it can be furnished mounted in the piano bench and connected by means of a cable and plug to the DynaTone.)

The radio tuner is a fairly simple one, since the DynaTone is designed primarily as a musical instrument and tone-quality has been stressed rather than extreme distance or short-wave reception. (A band from 16 to 50 meters is, however, provided.)

A tone control is provided for use on the radio set and records, but is not recommended for the reproduction of the piano tones, since these should be reproduced in their proper value, without the discrimination a tone control always introduces. The 4 controls at the extreme right of the keyboard (see insert in Fig. A), from left to right, are as follows: Treble, Volume, Bass, and 4-position Selector (1—Regular Piano, 2—Electronic Piano, 3—Phono and, 4—Radio).

OTHER FEATURES

Another feature of the DynaTone, which is especially valuable to teachers and students, is the provision for mixing the sound from the record with that from the piano keys. The speed of the turntable motor can be adjusted to bring the record into exact tune with the piano scale, and the volume can be adjusted for any proportion between the two. In this way, the student can play a record by some well-known pianist and by following it on the keyboard can attempt to duplicate the technique of the original master.

Yet another point of interest is that, with the amplifier inoperative (selector switch at Regular Piano—that is, amplifier switch snapped "OFF"), an exquisite tone is produced but which, because of the absence of a sounding board, does not carry far. Operated in this manner, it will not disturb neighbors (late at night, for instance), or those who may be in a nearby sick-room.

The price of the complete DynaTone is less than \$600, while a good grand piano costs from \$800 up (yet an estimated 10,000 of the latter have been sold, to date, at an average figure considerably above the stated minimum—Editor). It is felt that the DynaTone, as the "piano of the future," has considerably better sales possibilities.

In any case, it is certainly worthwhile for radio dealers and Servicemen to familiarize themselves with the new developments in electronic musical instruments, since they are sure to play an important part in the future of the electronic industry.

This article has been prepared from data supplied by courtesy of Ansley Radio Corp.

Please Say That You Saw It in RADIO-CRAFT

John Meck
presents
TWO NEW INSTRUMENTS



The BRIDGEMASTER

More than a condenser analyzer. An easily used bridge for inductance (10 to 4000 mh.), resistance (½ ohm to 1000 megohms), capacity, power factor and leakage measurements. Condenser leakage read directly on calibrated scale in terms of INSULATION RESISTANCE (up to 1000 megohms). Only the BRIDGEMASTER offers this method of determining condenser worth, the only test approved by all manufacturers. RATED VOLTAGE (variable from 10 to 500 volts) applied to condenser under test to assure true operating conditions. GUARANTEED FOR TWO YEARS. Hand rubbed cherry walnut finished carrying case. Write for new engineering bulletin. Dealer net

\$29.50



The TUBEMASTER

Revolutionary circuit tests MUTUAL CONDUCTANCE, EMISSION, and POWER OUTPUT in one quick reading on illuminated GOOD-BAD meter scale. Sells more tubes, solves more trouble than tester making but one of these three important tests. Hot neon short test. Checks every tube announced to date including latest grid at base and LOC-TAL types. GUARANTEED FOR TWO YEARS against OBSOLESCENCE! Control panel translucent dialophone illuminated from below. 10 inch illuminated giant roll chart. Get full details today. Dealer net

\$29.50

Write for Catalogue—TODAY

JOHN MECK INSTRUMENTS

162-D N. May St., Chicago, Ill.

FREE "When to Replace Condensers"

Send me at once a copy of your FREE 8-page bulletin showing when to replace condensers in accordance with manufacturer's commercial tolerances.

Name

Address



RADIO— MANY OPPORTUNITIES STILL AHEAD

• The radio industry has hit its full stride! The future, with Television, presents great opportunities—for the trained man! The I. C. S. Radio Course, prepared by experts in practice as well as theory, is constantly revised to meet new developments. This Course can make you a trained man — prepare you for promotion and a trained man's salary! Send for free booklet.

INTERNATIONAL CORRESPONDENCE SCHOOLS

Box 6676-E, Scranton, Penna.
Send me—free—information on subject checked:
 Radio Radio Service Man
 Radio Operator Electrical Engineer

Name: _____
Address: _____

HUNDREDS of brand-new servicing hints . . . a wealth of practical engineering information . . . 16 pages of valuable data compiled in table reference form . . . page after page of important sales and servicing helps—all this and more is contained in Sylvania's new "Service Hints" book, volume III. Get your copy FREE—send today to Hygrade Sylvania Corp., Emporium, Pa.

SYLVANIA SET-TESTED RADIO TUBES

FREE! FREE!

One tube free for every \$5.00 order

TUBES		CONDENSERS	
1V	\$.25 6C5	\$.35	400 Volt
2A7	.35 6F5	.001-.006	5c 600 Volt
6A7	.30 1H4G	.35 .01-.05	6c .001-.005 6c
6F7	.50 5S	.20 1-.2	8c .01-.05 6c
6AB	.35 42	.30 .25-.5	9c .25 10c

Tubes guaranteed for 3 months
1,000 Volts .001-.008 10c
.01-.05 12c

RESISTORS 2 Watt 9,000, 10,000, 12,000, 15,000 ohms—4c ea.

All merchandise high quality, standard brands, fully guaranteed. Free catalogue.

NEW YORK RADIO SUPPLY CO.

152 W. 42 St. N. Y. C.

GOOD MEN IN RADIO HAVE GOOD JOBS

You need something more than just "good intentions" to get ahead in Radio. Today's opportunities go to the men with TECHNICAL TRAINING. Our booklet, "A Tested Plan" tells how YOU can improve your position. Write for your FREE COPY right now to—
CAPITOL RADIO ENGINEERING INSTITUTE
Dept. RC-1A 3224-16th St., N.W. Washington, D. C.

6-VOLT UNIVERSAL POWER PACK

LISTS \$15.00 At Less Than Price 6-Prong Synchronous Vibrator Alone!

Operates 2 volt set from 6 volt storage battery, also operates 6 Volt house sets, auto sets, S.W. transmitters and receivers. Output, 180 Volts at 50 M.A. On 4 Volt cell supplies 120 Volts at 30 M.A. Housed in case 3"x4 1/2"x2 1/2" Ship ping Wt. 6 lbs. **Only \$32.95 NET**

25% Deposit Required with Order, Balance C. O. D.
ARROW SALES CO. 27 S. JEFFERSON ST. CHICAGO, ILL.

COMPLETE STEP-BY-STEP DYNAMIC SERVICING

(Continued from page 405)

he cannot get best efficiency from his car by simply replacing spark plugs when the engine starts missing, or by putting in a new distributor condenser when the old one has reached the end of its useful life.

Motor tune-ups and dynamic motor and ignition tests have been successfully sold by automotive service shops for years, plus new points, if needed, new plugs or condenser, if needed, etc., etc. Most important, dynamic tests to sell such service are run before the customer, so he can see for himself what he needs and what he's getting for his money by way of better, smoother, guaranteed performance.

Capitalize the "tune-up" idea in talking to your customer—PUT ACTION INTO YOUR SERVICE-SELLING PROCEDURE. Display before him the chart of Fig. B (or preferably, an enlargement of it, which is available at nominal cost). Have a trimming condenser on your bench to show him. Explain how the metal blades of the trimmers in his set have been under constant tension since the receiver was made, and how age and vibration have more often than not upset these trimmers so that he is not getting original factory-performance. Then show him you have the equipment and the knowledge to give him a complete 14-point tune-up that will not only locate trouble and defective parts but give him performance as good as when his receiver was new.

By thus "dramatizing" your service-selling procedure you will be doing your customer a favor and at the same time *legitimately* building up your service check!

TEST SEQUENCE

In what order should you make the tests? For convenience, the tests have been numbered 1 to 14 in the diagram Fig. B. This is a logical order but, as you can see, the receiver circuit naturally divides itself into 2 sections: the radio-frequency portion, tests 2 to 9; and, the audio-frequency portion, tests 10 to 13.

Test 1 logically always is made first, in order to make sure that the power pack is operating correctly. With that out of the way, it makes no difference whether you make tests 2-9 first, or 10-13. Having started one or the other, however, perform consecutively every test in the group in a thoroughly workmanlike manner.

Test 14 should always be made after the others, in order to make sure that the overall performance of the receiver is up to the mark.

STEP-BY-STEP PROCEDURE

The remainder of this article is given to detailed instructions for the various tests which constitute the 14-point dynamic check-up.

Section 1 gives instructions for operating the controls of a typical oscilloscope (as exemplified by the Model 127 "Graphoscope") as a necessary preliminary to actual work, while the remaining sections give directions for specific tests, diagrammed in Fig. B.

CAUTION: Cathode-ray tubes are subject to damage through use of beam intensities too great per unit of screen area. Since tubes are not guaranteed either by the tube manufacturer or the instrument manufacturer against misuse of this character, every precaution to avoid it should be taken.

Never focus the spot on the screen without having voltage applied to either the horizontal or vertical plates. Then turn up the intensity only enough to form a well-

defined trace. For observing complex patterns, somewhat higher intensity may be needed, but in such cases the intensity should be lowered before deflecting voltage is removed.

To avoid excessive intensities do not face the tube directly into bright light. Here a tube shade will prove helpful.

*INPUT IMPEDANCE AND SENSITIVITY

Sensitivities

Vertical Amplifier	0.26 V. r.m.s. inch
Horizontal Amplifier	6.8 V. r.m.s. inch
Vertical Plates (no amplifier)	25 V. r.m.s. inch
Horizontal Plates (no amplifier)	20 V. r.m.s. inch

Input Impedances

To Vertical Amplifier	1 meg.
To Horizontal Amplifier	2.5 megs.
To Vertical Plates (no amplifier)	5 megs.
To Horizontal Plates (no amplifier)	2.5 megs.

*These specifications are fairly typical for all good-grade oscilloscopes but are specific for the Clough-Brengle Model 127.

SECTION I

SETTING UP THE CATHODE-RAY UNIT

THE SCALES

Two transparent scales are provided: One has non-uniform graduations, for use in frequency alignment; the other has 10 uniform graduations in each direction, for general use. Place the latter in the grooves of the rubber bumpers around the end of the tube and move down firmly to the stop.

INTENSITY AND FOCUS CONTROLS

Make certain that the line voltage and frequency correspond to the nameplate markings, then connect the instrument.

Turn the INTENSITY control from the OFF position to one approximately vertical. After the C.-R. tube has had about 3 minutes to warm up, turn the FOCUS and INTENSITY controls until a green line or haze shows on the screen of the tube. Turn the HORIZONTAL amplitude control to about "5" (on the particular instrument we have selected for reference), the SWEEP control to "60 Cycles," and the VERTICAL control to "0."

Adjust INTENSITY and FOCUS until the line on the screen is about 1/64-in. wide.

BEAM CENTERING

The beam-centering controls are marked DOWN-UP and LEFT-RIGHT. These should be turned until a well-centered trace is obtained as in Fig. 1A. This is the normal initial adjustment of the cathode-ray tube for most purposes.

TRUEING-UP THE TUBE AXES (if necessary)

In final inspection of the instrument, the tube is locked to give the above adjustment. If it has shifted in shipment, the trace in Fig. 1A will lie at an angle to the graduations on the screen. It will then be necessary to get at the tube mount and rotate the 906 tube to bring the trace in line with the scale.

APPLICATION OF VOLTAGE TO THE VERTICAL DEFLECTING PLATES

With the above adjustments, the instrument is ready for the study of voltages applied to the vertical plates. The upper of the pair of binding posts for this connection is marked VERT. The lower post, marked GND., should always be connected

Please Say That You Saw It in RADIO-CRAFT

to the ground or the chassis side of the circuit under test. If the instrument is used in a room containing stray fields due to equipment or wiring, it will be necessary externally to ground this terminal to prevent spurious deflections.

To gain familiarity, connect some source of A.C. voltage such as a filament winding to the VERT. posts. Turn the VERTICAL amplifier control until the pattern is 10 divisions high on the screen. You will recognize one of the patterns in Fig. 1B, depending on the applied voltage phase.

Adjust width of the pattern by the control marked HORIZONTAL.

USING THE VERTICAL PLATES WITHOUT AMPLIFICATION

Conditions may require the use of the vertical deflecting plates without amplification, as when the voltage to be viewed is high (50-400 volts), or when the frequency of the voltage is so high as to be outside the range of the amplifier (above 100,000 cycles).

In such cases, the test voltage may be applied to the binding head screw marked "V" on the rear of the case, after the strap connecting the 2 posts has been removed.

ADJUSTING THE LINEAR SWEEP

The linear sweep circuit consists of an 884 tube, functioning as a sawtooth-wave generator, together with a 42 tube, connected as a triode and so biased as to straighten out the inherent non-linearity of the condenser-charging cycle and thereby to bring the sweep to a perfectly linear condition.

To apply the linear sweep to the horizontal circuit, turn the SWEEP control to LINEAR.

The operation of the linear sweep circuit is controlled by 3 knobs, grouped and designated VERNIER, FREQUENCY and SYNC. (synchronization).

The FREQUENCY control governs the number of sweeps per second (sweep-rate) of the sawtooth generator in 6 steps, as marked on the panel.

The VERNIER control selects the exact frequency of the sweep between steps. For example, with the FREQUENCY control set to the second step, marked 55-190 on the panel, the VERNIER will permit selection of any sweep rate between 55 and 190 sweeps per second.

The SYNC. control permits application of voltage to the grid of the 884 tube in such manner as to hold the pattern stationary on the screen of the tube.

To observe the action of the linear sweep, leave the A.C. voltage connected to the vertical input posts as described under "Application of Voltage to the Vertical Deflecting Plates," turn the SWEEP control to LINEAR, CONTROL to INTERNAL, and SYNC. to "0." Turn the FREQUENCY knob to 55-190 and rotate the VERNIER knob until the pattern of Fig. 1C is observed. This is one cycle of the 60-cycle wave under observation.

If the FREQUENCY is lowered to the 15-55 step and the VERNIER slowly adjusted, the patterns of Fig. 1D and 1E will be seen. The first indicates 2 cycles of the wave observed, and the second 3 cycles. The sweep rates are respectively 1/2 and 1/3 of the frequency of the voltage connected to the VERT. binding posts.

CONTROL OF THE PATTERN

(Synchronization)

When the desired pattern has been obtained, it will drift across the face of the tube, unless a small voltage of the same or related frequency is applied to the grid of the 884 tube to synchronize the sweep rate.

The source of this voltage is selected by

the CONTROL switch. The amount of voltage is governed by the dial marked SYNC.

With the CONTROL switch on INTERNAL, control voltage will be obtained from the vertical circuits within the instrument.

With the CONTROL switch on EXT. (external), control voltage may be applied through the binding post marked EXT. SYNC.

With the CONTROL switch on FREQ., control voltage is from the power rectifier circuit, where 120 control-pulses per second are obtained and properly phased for running selectivity curves on the intermediate-frequency amplifier of a radio receiver.

Familiarity with synchronizing the pattern may be gained by using the set-up and connection described under "Application of Voltage to the Vertical Deflecting Plates," and setting the CONTROL switch to INTERNAL. With the SYNC. dial turned to "0," the VERNIER should be turned until the pattern is correct and virtually standing still. The SYNC. dial may then be turned up until the pattern is perfectly stationary.

Always use the least amount of SYNC. voltage which will stabilize the trace. Do not make a hasty, careless adjustment of the VERNIER, and then introduce an excessive amount of synchronization voltage to hold the pattern stationary, since this will result in distortion of the observed waveform.

When adjusting the linear sweep for observing high-frequency waves, it will be helpful to advance the SYNC. control one or two points while adjusting the VERNIER. This will prevent the synchronous patterns from flying past unobserved.

DOUBLE TRACES—MULTIPLE TRACES

Misadjustment of the sweep to a frequency higher than the frequency of the wave under test will give stationary patterns which will be multiple traces of no value. Such a trace is shown in Fig. 1F, where the sweep frequency was 3/2 of the observed frequency. Such traces are also produced at 2/3, 3/4, 4/5, etc.

To correct multiple traces simply reduce the sweep rate until a single trace of the desired number of cycles is seen. Then synchronize.

AMPLIFICATION ON THE HORIZONTAL PLATES

A few applications call for amplification of an external voltage to the horizontal plates, where available voltage is too small to give a suitable deflection.

This is provided by turning the SWEEP switch to LINEAR, and the FREQUENCY switch to the position marked TO HOR. THRU AMP. The external voltage may then be connected to the horizontal input binding posts for amplification by the 42 tube of the linear sweep circuit, before being applied to the deflecting plates.

LIMITATION OF VOLTAGES APPLIED

To avoid damage to any of the internal parts of the instrument, it is important that the peak voltage applied to the horizontal or vertical binding posts be limited to 400 volts.

This requires an external transformer or dropping resistor for higher A.C. potentials, and a guard circuit consisting of a condenser and resistor, for circuits having higher D.C. potentials. In applying external protective circuits, care should be exercised to see that the circuit reactances are such as not to distort the wave to be observed.

Part II, containing Sections 2 and 3, will describe how Dynamic Testing may be employed to check power supply performance, and to test vibrators.

This article has been prepared from data supplied by courtesy of Clough-Brengle Co.

LAFAYETTE Mystery RECORD PLAYER



THRILL-PACKED ENTERTAINMENT IS YOURS with the sensational new Lafayette Mystery Record Player. Imagine an electric phonograph that plays through your radio (regardless of age, make or type) without any connection to the radio. There are no wires to attach. Play this magic instrument anywhere in the house. Simply plug it into any 110-volt a.c. outlet. Latest type tangent arm crystal pick-up assures perfect, higher fidelity reproduction. Your radio controls both volume and tone. Plays either 10" or 12" records. And what fun you can have at parties with the special microphone connection that lets you "announce" programs—be the life of the party. No home should be without the entertainment provided by Lafayette's Mystery Electric Record Player—

A SENSATIONAL BUY \$14⁷⁵



Send for sensational FREE catalog made to order for thrifty buyers. Here's radio in all its glory—60 beautiful new 1939 receivers—every one a "Miracle" buy! New P. A. section that will open your eyes. Latest type tubes, parts, television, build-your-own kits, "ham" apparatus, equipment at all-time low prices. More honest values packed into the 188 pages of this one book than you've ever seen before. Get your FREE copy at once. Just mail the coupon.

WHOLESALE RADIO SERVICE CO. INC.
 NEW YORK, N.Y. • CHICAGO, ILL. • ATLANTA, GA.
 109 3/4 E. 27th St. • 101 W. Jackson Blvd. • 348 Peachtree Street
 BOSTON, MASS. • BRONX, N.Y. • NEWARK, N.J. • JAMAICA, L.I.

WHOLESALE RADIO SERVICE CO., Inc.
 Dept. 3A9-100 Sixth Ave., New York, N. Y.
 Send record player bulletin No. 3
 Rush FREE 1939 Radio Catalog No. 73

Name _____
 Address _____
 City _____ State _____

PASTE COUPON ON PENNY POST CARD

Please Say That You Saw It in RADIO-CRAFT

EXTRA! BARGAIN BULLETIN
BIG MONEY SAVING CATALOG
Just off the press

JUST A FEW OF 500 ITEMS AT NEW LOW PRICES

New 1939 Camden 5 Tube RADIO-PHONE COMBINATION

Superb performance. Police calls and broadcast pickup. Plays up to 12 records. Dynamic Speaker. Walnut cabinet. Each \$16.95. Lots 3 net each **\$15.95** with tubes



FLEETWOOD ELECTRIC RAZOR

Sensational Value! Quick, clean shaves without brush, blades or lather. No cuts. No irritation. AC. Net each **\$1.39**



AIRMASTER 1939 5 TUBE AC-DC RADIO

Biggest "Little Radio" Value! Amazing volume, superb tone. Illuminated airplane dial. Dynamic speaker. Range 540-1750 KC. In rich walnut cabinet. **\$6.95** with tubes



MAIL THIS COUPON FOR FREE CATALOG

RADIO CIRCULAR CO.
 918 Broadway, New York, N. Y.
 Rush Free Copy of BARGAIN BULLETIN. No obligation.

Name _____
 Address _____
 City _____ State _____

FREE TRIAL OFFER
NEW REMINGTON NOISELESS PORTABLE!
 AS LITTLE AS



10¢ A DAY

Famous Remington Noiseless Portable that speaks in a whisper. Pay as little as 10¢ a day. Guaranteed by the factory. Standard keyboard. Automatic ribbon reverse. Variable line spacer and all the conveniences of the finest portable ever built. PLUS the NOISELESS feature. Act now. Send coupon TODAY for details.

You don't RISK a Penny

We send you Remington Noiseless Portable for 10 days' free trial. If not satisfied, send it back. We pay all shipping charges.

Typing Course and Carrying Case

You will receive FREE a complete simplified home course in Touch Typing, a handsome sturdy carrying case is included. No obligation. Mail coupon for full details—NOW.

Remington Rand, Inc., Dept. 189-1,
 465 Washington St., Buffalo, N. Y.
 Tell me, without obligation, how to get a Free Trial of a new Remington Noiseless Portable, including Carrying Case and Free Typing Course for as little as 10¢ a day. Send Catalogue.

Name _____
 Address _____
 City _____ State _____

LES Correspondence Courses in RADIO and ELECTRICAL ENGINEERING

ELECTRICAL ENGINEERING Get good grasp of wide electrical field. Prepare yourself, at Low Cost, for secure future. Modern, simplified, you can understand quickly.

RADIO ENGINEERING Extra fine course in radio, public address, photo-electric work, etc. Includes school catalog, student technician. Exer. kits furnished. Diploma on completion. Tuition, \$25. Get copies of school catalog, student magazines, complete details. **SEND NOW!**

FREE

LINCOLN ENGINEERING SCHOOL, Box 931-C1, LINCOLN, NEBR.

FREE NEW CATALOG 1939 AMPLIFIERS

Featuring amazingly low prices; Free Trial, Offer: 5-Year Guarantee. Write for Catalog No. 3911.

AMPLIFIER CO. of AMERICA
 17 WEST 20th STREET NEW YORK, N. Y.

RADIO TRADE DIGEST

DILATORY U.S. MANUFACTURERS MAY LOSE TELEVISION MARKET

(Continued from page 417)

appear that each fears the others' plan to steal a march; for example, Stromberg-Carlson, strongly rumored as a coming telly mfr., sent no data.

Excerpts from some of the answers follow:—

International Radio Corp., Ann Arbor, Mich.:—"We do not plan to produce home television sets until television broadcasting is successful in the larger cities of the United States. We do not plan to enter that (the coming N.Y.C.—Ed.) market."

Emerson Radio & Phonograph Co., N.Y.C.:—"We are definitely going ahead with television development and expect to have our receivers ready next spring."

Philco:—"Nothing as yet regarding Philco's manufacturing television receivers."

Howard Radio Co., Chicago, Ill.:—"No details at this time."

Galvin Mfg. Corp., Chicago, Ill.:—"Unable to release for publication information re television plans."

American Bosch Corp., Springfield, Mass.:—"Unable to give you answer at present time."

Majestic Radio & Television Corp., Chicago, Ill.:—"At the present time, we have no plans for entering the television field."

General Electric Co., Schenectady, N.Y.:—"Our plans for production of television receivers during 1939 are at present indefinite."

Fairbanks, Morse & Co., Indianapolis, Ind.:—"At this time we have no immediate plans for producing television sets. It is our feeling that the entire matter is too much in its embryo stage for any such plans to be announced, though of course we will watch the situation carefully."

Pierce-Airo, Inc., N.Y.C.:—"We do plan to manufacture several models of home television receivers. We, however, do not plan to bring these out in the market until next spring, as our plant is running full capacity now, endeavoring to fill our orders for broadcast receivers."

Crosley Radio Corp., Cincinnati, Ohio:—"This company does not plan on producing any television sets."

Sentinel Radio Corp., Chicago, Ill.:—"At present we do not manufacture home television sets and are sorry that we cannot give you any further information concerning the future as we do not have any definite information available at this time."

Westinghouse Electric & Mfg. Co., East Pittsburgh, Penna.:—"Our radio division does not contemplate the manufacture of home television sets at this time."

Garod Radio Corp., N.Y.C.:—"We are at present in production on the Telesor Kit but we have not set any definite date when we will be in production on complete television receivers in cabinet form."

Wells-Gardner Co., Chicago, Ill.:—"While we are quite naturally interested in the promotion of television receivers, we have made no definite production plans. As a contract manufacturer, we must wait upon our various sources of distribution before developing and producing any new article of merchandise."

Montgomery Ward & Co., Chicago, Ill.:—"At the present time, at least, we do not plan on producing home television receivers."

Allen B. Du Mont Labs.:—"The organization is now producing several dozen television sets a week, and is having no diffi-

culty disposing of them. . . . There are two models, one a table model (\$395) and the other a console (\$445). . . . These 21-tube sets produce a picture of 8 x 10 inches. . . . This company has long enjoyed a cross-license agreement with Cossar, a leading radio manufacturer of Great Britain, whereby there has been a very profitable interchange of television and cathode-ray patents."

American Television Corp., N.Y.C.:—"When production requirements make it necessary, we can begin immediately on a scale of 500 sets a month. . . . Thus far more than 150 sets have been sold to buyers in various parts of the country. . . . For several weeks we have been turning out a weekly quota of Videors which are intended for delivery within the next month to department stores and dealers, each of whom will get 2 or 3 for display and demonstration and for early-delivery orders. These deliveries will be made when we have some assurance of telecast schedules upon even the most experimental basis."

Other items of interest in the telly field include RCA's acquisition of rights under patents granted to Harry Lubcke, telly director of the Don Lee net.

Also reported is a drive by Amer. Television Corp. for joint sponsorship of telly programs by mfrs. of sets & parts, & a "special royalty" plan to create a "sustaining program fund" for RCA.

\$'s & No.'s Dept.

(Continued from page 420)

expenditures, \$2,340 a wk.; uses 17 stas.; reaches 56.7% of U. S. population; in about 50% of cases uses coast-to-coast.

G-E ORDERS DOWN 38% in first 9 mo. of '38 as compared with '37, this yr.'s orders totalling \$188,756,958.

CANADIAN DEALERS sold 25,927 sets, valued at \$1,909,176, in August. The \$'s were down but the # was up, as compared with previous yr.

RADIO FACTORY employment in July upped 0.1% over June, but was 53.1% below '37. Layoffs, however, were only about 1/3 as great as preceding year. Average weekly wages were down 2.5% from '37, and average hours worked were down a similar amount. Average hourly pay was 61c—0.1% below previous yr.

RADIO EXPORT continued its slump in Aug., but was only 22% below same mo. of '37. Components, parts, and accessories showed increase over preceding yr. All other apparatus except speakers showed gain on preceding mo., though less than in Aug. '37.

EXCISE TAX collections show Chicago as leading center of radio production, with Camden 2nd and Philadelphia 3rd. Collections for U. S. were \$5,848,841 for yr. ending June 30, '38, as compared with \$6,754,272 for same period in '37, and \$5,075,270 for '36.

DIMINISHING DIVIDENDS at G-E again, with 61c per share available at end of Sept. '38 as against \$1.38 at end of Sept. '37. Both income and expenses were down.

Please Say That You Saw It in RADIO-CRAFT

RADIO TRADE DIGEST

SIDE ROADS TO EXTRA PROFITS

(Continued from page 417)

gaged in making radio apparatus:—

Should have no sideline	24.2%
P.A. & phono. equip't	13.8
Electrical appliances	13.8
Household appliances	13.8
Refrigerators	10.3
Air-conditioning equip't	6.8
Radio parts	6.8
Practice sets	3.5
Cameras	3.5
Electric fans	3.5

Possibly the same sort of article was meant by "Electrical" & "Household" appliances, but these were two separate items written-in by questionees. The fact that only 24.1% of the replies suggested parts, amplifiers and other radio equipment is probably due to most of the questionees thinking of such items as main lines, rather than sidelines.

DEALERS MIGHT TRY THESE

Sidelines suggested for dealers ran through an even wider range of items. The tabulation was:—

Electrical appliances	19.6%
Refrigerators	19.3
Household appliances	16.3
P.A. & phono. equip't	11.5
Service	11.5
Cameras	5.5
Air-conditioning equip't	5.5
Parts	2.7
Practice sets	2.7
Clocks	2.7
Electric Fans	2.7

Out of such a bunch of suggestions, there must be at least 1 which will bring in the shekels when seasons are slack. Best bets would appear, at first glance, to be items polling highest percentages. But don't forget that competition & ability to handle are important.

RTD is now preparing a new Questionnaire to take up other questions of vital interest to radio men. Watch for results in an early issue.

SNOOPS & SCOOPS

(Continued from page 418)

when telly breaks in the spring, though there are doubts . . . New *Clarostat* fixed resistors will operate at red-heat without being harmed.

Demonstrations of Philco's *Mystery Control* are stopping traffic, and do my ears burn! . . . Radolek has a new 25-w. P.A. system with 150 db. gain . . . 3,497,842 man-hours without a disabling accident was Sylvania's safety record in the Emporium plant . . . DeWald's *Bantam*, selling under \$10, is going great guns . . .

RCA is cashing-in on the late G. Gershwin with a 32-record album of his tunes, based on the Magic Key Memorial broadcast . . . Prizes in 3rd Annual Modern Plastics Contest:— 1st in Household Group, *Zenith's Radio Nurse*; 2nd in Decorative Group, *Pee-Wee Detrola*; Hon. Mention, same group, *Emerson's College Models*.

NBC is giving its Fla. advertisers a bonus, by tossing in time on *WLAK*—free . . . And their new selling policy allows special discounts on the *Blue net* when supplementary groups are used with the basic web . . . A new web is being plotted for the *Southwest* . . . New Republic Radio Corp., Newark (N.J.) subsid. of Duro-Test (lamps) Corp., will make tubes.

PERSONAL

(Continued from page 418)

F. B. (Fine Business) ROGERS has become Divisional Sales Mgr. of Ampro Corp., with hq. at the co.'s N.Y.C. office, 56 West 45th St. His son, F. B. R., JR., assists him. HARRY S. MILLER is handling Metropolitan N. Y. for the co. F. B. R. was formerly in the 16mm movie biz.

WILLIAM J. DEMPSEY has replaced HAMPSON GARY as general counsel to the FCC. No charges—Com. McNinch simply didn't like Gary's work.

MARSHALL P. WILDER, of National Union, is going around lecturing on television.

ELLSWORTH C. DENT is credited with boosting RCA biz in the educational field, according to Commercial v-p Henry C. Bonfig. More expansion of the Dent Dept. is planned.

WALTER F. MARSH, gen. sales mgr. for Meissner, reports jobber approval of the new 1-, 2- & 3-tube kits in Ill., Ia. & Wis.

E. L. CAVE, Shenandoah, Va., HOFFMAN'S RADIO SERVICE, Edgewood, Ill., ALPHONSE F. PELOVSKY, Le Center, Minn., JOHN H. SCHWARZKOPF, Chicago, Ill., & WEST KENTUCKY COAL Co., Sturgis, Ky., tied for 1st place in the RCA trademark ("His Master's Voice" Victor dog) contest. They estimated amount spent to advertise "Nipper" at \$15,000,000; right total was \$14,999,486.72. Each wins \$1000 in mdse. Wrong guesses ran from \$1,035 to \$85,000,000,000. Prizes went to 52 entrants, in all. (See Pic., P. 419.)

CHANGES & NEW ADDRESSES

(Continued from page 419)

MURPHY & COTA, 291 Peachtree St., N.E., Atlanta, Ga., have been appointed Atlas Sound Corp. sales reps for Ga., Tenn., & N. & S. Car.

J. E. MCKINLEY, 1819 Ridge Ave., Corapolis, Pa., will assist John O. Olsen of Pittsburgh; will travel W. Va. & part of Western Pa. for Atlas Sound.

STUART D. CLAYTON, 10827 South State St., Chicago, Ill., represents Radio City Products Co. in Ind., Wis., & southern Ill.

GEORGE N. CAMERON, 2662 Shaker Road, Cleveland, O., represents same co. in Ohio & Ky.

OFF THE PRESS

(Continued from page 420)

CATALOG. Aerovox Corp., Brooklyn, N. Y. Condensers.

TEST STANDARDS FOR CONDENSERS. 8 pp. John Meek Instruments, Chicago, Ill.

CATALOG. 48 pp. Capitol Radio Engineering Institute, Washington, D. C. Describes courses and facilities.

CATALOG 33. 36 pp. Leotone Radio Co., N.Y.C. speaker and other replacement parts.

AMPLIFIERS & SOUND SYSTEMS. 32 pp. Wholesale Radio Service Co., N.Y.C. List prices on Lafayette amplifiers and accessories.

GIFT CATALOG. 64 pp. Wholesale Radio Service Co.

GREATEST SELLING OPPORTUNITY IN SOUND HISTORY. 44 pp. Webster Co., Chi., Ill.

NOTICE

Due to unforeseen circumstances Part II of the article, "Play Talkies Through Your Radio Receiver," will appear in the forthcoming February issue instead of the current issue.

Please Say That You Saw It in RADIO-CRAFT

Triplet is the leading manufacturer of volt-ohm-milliammeters, combining 2% precision accuracy with economical prices.



DEALER PRICE \$31.17

Model 1200-E

Volt-Ohm-Milliammeter

- Resistance Readings to 40 Megohms.
- Separate A.C. and D.C. Instruments in Tilting Twin Case; Accuracy of Each Within 2%.
- For All Radio Measurements Not Requiring a No Current Draw Vacuum Tube Voltmeter.

Model 1200-E offers a new order of precision testing with 25,000 Ohms per Volt. Modern radio sets that require delicate balancing can be easily and quickly adjusted. READINGS: D.C. Volts 0-10-50-250-500-1000 at 25,000 Ohms per Volt. A.C. Volts 0-10-50-250-500-1000. 0-50 D.C. Microamperes, 0-1-10-50-250 Milliamperes; Resistance 1/4-1000 Low Ohms; Backup Circuit; 0-40,000 Ohms; 4 and 40 Megohms.

Model 1200-E has two instruments, A.C. and D.C., in tilting type twin case. Switch contact error less than 1/2% on milliamperes. Ohms scale markings in straight lines. Resistance measurements have individual zero adjustments. Selector switch for all readings. Contains 22 1/2 and 1 1/2 volt batteries.

A TRIPLET MASTER UNIT . . . one of a series of co-related single unit testers made in standard sizes, the most economical method yet devised for completely equipping the all-around radio service shop with high quality instruments. Catalog gives complete information regarding other Triplet Volt-Ohm-Milliammeters.

OTHER TRIPLET VOLT-OHM-MILLIAMMETERS

- Model 1200-A . . . same as 1200-E but 2000 ohms per volt D.C. . . . DEALER NET \$23.83
- Model 1200-B . . . same as 1200-A but with D.C. movement and copper oxide rectifier for A.C. readings. DEALER NET . . . \$29.33
- Model 1200-C . . . same as 1200-A but with 5000 ohms per volt D.C. . . . DEALER NET \$26.83
- Model 666 . . . Popular Pocket Size Volt-Ohm-Milliammeter . . . DEALER NET \$15.00



THE TRIPLET ELECTRICAL INSTRUMENT CO.
161 Hamon Ave., Bluffton, Ohio

Please send me more information on

- Model 1200-E; Model 1200-A;
- Model 1200-B; Model 1200-C;
- Model 666.

Name

Address

City State

MODERNIZE

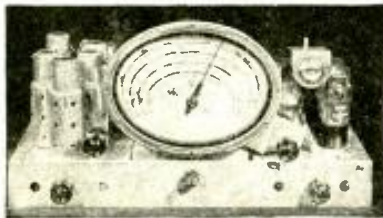

WITH THE ULTRA NEW
BROWNING 83
 HIGH FIDELITY KIT
Extra Profits for the Service Man
 Address Dept. RC-1
Browning Laboratories, Winchester, Mass.

TELETRAN!?

MOST COMPLETE LINE OF P.A. and ACCESSORIES ON THE MARKET TODAY.

Write for 20-page Catalog.

Licensed by ERPI under patents owned or controlled by A. T. & T. and Western Electric

TELETRAN PRODUCTS CO.
 2233 University Ave.
 St. Paul Minnesota

YOUR FUTURE IN RADIO TELEVISION

These growing industries need trained men for sales, service, operation. Your chance for employment and advancement depends on thorough training. National Schools offer you time-tested training. Complete, modern facilities and equipment in the largest trade school in the West.

Send for free booklet that shows how you can prepare for these opportunities.



NATIONAL SCHOOLS
 4000 S. Figueroa Street, Los Angeles

NATIONAL SCHOOLS, Dept. RC-1, Los Angeles
 Please send free Radio and Television Booklet.

NAME _____ AGF _____
 ADDRESS _____
 CITY _____ STATE _____

PATENT'S—TRADE MARKS

All cases submitted given personal attention by members of the firm.
 Form "Evidence of Conception" with instructions for use and "Schedule of Government and Attorneys Fees"—Free
LANCASTER, ALLWINE & ROMMEL
 PATENT LAW OFFICES
 436 Bowen Bldg. Washington, D. C.

WE HAVE The RADIO YOU WANT

Our 1939 catalog is chock full of new Standard Brand Radios for Home-Farm-Auto, over 400 models. Also hundreds of Electric Appliances for the home. Celebrating our 50th Anniversary with Big Bargains. Write for your copy today. It's FREE.
 MODEL'S Dept. 57 Corlandt St., N.Y.C.

RADIO COURSES

New Classes Now Starting
 RADIO OPERATING—BROADCASTING
 ● RADIO SERVICING—a practical course
 ● RADIO AMATEUR CODE ● TELEVISION
 ● ELECTRONICS—1 yr. day course 2 yrs. eve. Day and Evening Classes. Booklet Upon Request.
New York Y. M. C. A. Schools
 4 W. 64th Street New York City

"FARMER'S FRIEND"

(Continued from page 407)

T2's slightly until maximum response is obtained. Reduce antenna length and retune above circuits. When the I.F. transformers have been properly aligned a "hiss" will be obtained without an antenna connected.

The adjustment of the center screw on each of these transformers should not be changed since this screw controls a link circuit which is accurately set at the factory and which is not affected by wiring capacities. This link circuit serves as a key to the I.F. alignment and, if not tampered with, makes it impossible to align the I.F. transformers at the wrong frequency which misalignment would, of course, cause the tracking of the receiver to be materially impaired.

R.F. ALIGNMENT

When the I.F. transformers have been adjusted, the trimmers on the various bands may be adjusted in the following manner:

Turn the band switch to Band 1; the volume control of the receiver should be advanced to maximum; tune to the amateur phone stations which should come in around 14.2 on the dial. If these stations do not occur exactly in this position on the dial, set the dial to this position and adjust the oscillator trimmers slightly until the signals are heard. The antenna and R.F. trimmers may then be adjusted for maximum response.

The trimmers on Band 2 may be adjusted in similar fashion using the 25-meter foreign band for the calibration. On Band 3, the police broadcasts may be used in the same manner. The oscillator section of this band is also equipped with a padding condenser. This condenser should be adjusted at some frequency toward the lower end of the dial (around 1.6 mc.). To make this adjustment, tune in a station in this region and adjust the Band 3 padder (the Band 3 padder adjustment is the one on the rear of the tuner chassis in the higher position) for maximum response. In making this adjustment, the tuning of the receiver must be varied as the padder is being adjusted, the correct adjustment being that for which the combination of dial setting and padder setting provides a maximum response.

In adjusting Band 4, broadcast stations, the frequencies of which are known may be used. The oscillator trimmer is first set by tuning to some known station at a frequency around 1.3 mc. The antenna and R.F. trimmers are then adjusted for maximum response at this frequency. When this has been accomplished, the padder on Band 4 (the Band 4 padder adjustment screw is that on the rear of the tuner chassis below the Band 3 padder adjustment) may be adjusted by tuning in some station around 0.6-mc. and following the same procedure as in the case of Band 3, that is, retuning the set as the padder is adjusted to obtain maximum response.

It is believed that the receiver described will be found to give excellent results in localities where A.C. power is not available. These localities have often been neglected in all-wave receiver design owing to the fact that economical battery operation was not heretofore obtainable. The chassis is laid out and drilled for the additional service of A.C. operation (by using a separate power supply).

LIST OF PARTS

One Browning Labs. BL-1 tuner;
 One Browning Labs. BL-1 dial and escutcheon;

OPPORTUNITY AD-LETS

Advertisements in this section cost five cents a word for each insertion. Name, address and initials must be included at the above rate. Cash should accompany all classified advertisements unless placed by an accredited advertising agency. No advertisement for less than ten words accepted. Ten percent discount for six issues, twenty percent for twelve issues. Objectionable or misleading advertisements not accepted. Advertisements for February, 1939, issue must reach us not later than December 5th.

Radio-Craft • 99 Hudson St. • New York, N. Y.

ADVERTISING AGENCIES

800 PROFITABLE MEDIUMS FOR CLASSIFIED ADVERTISERS! Just published, 24-page booklet, "Publication Directory of Classified Advertising Markets." Lists over 800 magazines (with addresses) according to industries, trades and services covered. Corlandt Advertising, 15 Park Row, New York, N. Y.

AVIATION

AIRPLANE MECHANIC'S LICENSE QUESTIONS, with answers, diagrams, \$1.25. **Engine Mechanic's** \$1.25. Both \$2.00 remittance. Meyer Engineering, Box 8, Hempstead, New York.

BOOKS AND MAGAZINES

WE HAVE A FEW HUNDRED RADIO ENCYCLOPEDIAS, by S. Gernsback, second edition, originally sold at \$3.95. Book has 372 pages, weight 3 lbs., size 9 x 12 inches. Red morocco—keratol flexible binding. Send \$2.49 in stamps, cash or money order and book will be forwarded express collect. Technifax, 558 W. Washington Blvd., Chicago, Illinois.

ASSURE YOURSELF OF GREATER PROFITS BY doing radio service jobs more quickly. Authentic service guides show you the way to locate and correct troubles in any radio receiver. Gernsback Official Radio Service Manuals show you how to complete more repair jobs in less time—how to earn more money by faster servicing. Turn to page 314 and learn how you can get Manuals on a free inspection plan.

"RACKETS THAT SWINDLE YOU," 15,000 WORDS, 166. "The Racket Series" (reprinted from Readers Digest), 30,000 words, 27c postpaid. Authoritative expose of non-violent frauds. Brock, 34-17 31st Ave., Astoria, N. Y.

USED CORRESPONDENCE COURSES AND INSTRUCTION BOOKS bought, sold, rented, exchanged. Catalog free. V. W. Vernon, Henagar, Alabama.

BUSINESS OPPORTUNITIES

RELIABLE PERSON IN EACH TOWN FOR OWN advertising distributing agency. No selling. Good paying business. Dawson's Advertising, Cape Girardeau, Missouri.

CAMERAS & SUPPLIES

GENERAL FILM. ANY 8MM. CAMERA. 200 FEET. \$1.75 postpaid. Separates without cutting. Processed with powders. Sample free. Promaders, Davenport, Iowa.

AMBERTINT 16MM. CAMERA FILM. \$1.85 FOR 100 feet, including machine processing. Daylight loading. Weston Film, Nonaharion, Two tolls \$3.00. Order now. Hollywood Studios, Southgate, Calif.

JOIN THE THOUSANDS OF CANOID CAMERA FANS—a genuine miniature equipped with Wollensak 50 mm. lens, speed shutter and accurate "spy glass" view finder. Fixed focus assures sharp pictures 1 1/2 x 1 1/4 inches. Enlarges with clarity up to 8 x 10 inches. Has special compartment to carry extra film roll and tripod socket for mounting. Uses economical Kodak 127 or Agfa A8 film in color or black and white—takes 16 pictures. Housing built of unbreakable bakelite composition. Camera weighs only 9 ounces; measures 5" long by 3" high by 2" wide. Easy to operate and inexpensive to use. Shipped postpaid anywhere in U.S.A. with guarantee of sale delivery—\$3.98. Hudson Specialties Company, 4814 West Broadway, New York, N. Y.

COINS AND STAMPS

20,000 VARIETIES. VALUE \$1,900.00. \$275.00; 2,000 varieties Portuguese, \$100.00; 3,000 varieties French Colonies, \$100.00; 100 all different Spain, \$2.00; 500 all different, \$3.00; 100 Jubilee, Combinations, Farleys, etc., \$5.00. National Parks Stamp Shop, Gloucester, Mass.

NINE AIRMAILS FROM SYRIA, GUATEMALA, LEBANON, etc., and others from Oceania, Manchukuo, Kenya, 5c to approval applicants. Lindgren, Box 118-C, San Francisco.

FOR INVENTORS

CASH FOR UNPATENTED IDEAS. STAMP FOR PARTICULARS. Mr. Ball, 5411 J Pleasant, Chicago, Ill.

INSTRUCTION

RADIO ENGINEERING, BROADCASTING, AVIATION and police radio, servicing, marine and Morse telegraphy taught thoroughly. All expenses low. Catalog free. Dodge's Institute, Pine St., Valparaiso, Ind.

LEARN CARTOONING FROM MY ORIGINAL DRAWINGS. First lesson free. Templeton, Lavalette, West Va.
PICTURED MUSIC READS ITSELF. ASK BLESSING. Box 147, Lansing, Michigan.

MISCELLANEOUS

MEXICAN DIVORCES; NO PUBLICITY. AMERICAN attorney. Box 1730, El Paso, Texas.

PYRO PANTAGRAPH—THIS ELECTRICAL OUTFIT burns designs permanently on leather, wood, cork, zourds, bakelite, etc. Simply plug pyro electric pencil into any 110 v. A.C. or D.C. line and it is ready to use. Reduce or enlarge any design with special pantagraph included. Complete kit and instructions, \$2.75. (Add postage for shipping 3 lbs.) Wellworth Trading Company, 560 E. West Washington Street, Chicago, Illinois.

MONUMENTS & TOMBSTONES

GENUINE MARBLE, GRANITE, FREIGHT PAID. Catalog free. \$11 up. United States Marble & Granite Co., A-27, Oneco, Fla.

(Continued on following page)

Please Say That You Saw It in RADIO-CRAFT

(Continued from preceding page)

OFFICE SUPPLIES

ENVELOPES—1000—6 3/4's \$1.75; 1000—10's—\$2.85; 100 sheets, carbon paper \$1.70; breadboard. "Everything for the office." Labahn, 103 Main, Evanston, Illinois.

PHOTOGRAPHY

ROLLS DEVELOPED—25¢ COIN. TWO 5 X 7 DOUBLE weight professional enlargements, 8 gloss prints. Club Photo Service, LaCrosse, Wisconsin.

ROLLS DEVELOPED—8 LARJAPRINTS (ENLARGEMENTS) 35¢ or 8 regular prints 25¢. Star Photo, New Britain, Connecticut.

PRINTING

100 PRINTED RADIO CALL CARDS \$1.00. 100 double-edge razor blades \$1.00, hostahold, Olsen Press, 1551 Southeast Powell, Portland, Oregon.

RADIO

NEW SURPLUS GOVERNMENT RADIO EQUIPMENT. real bargains, price list 3c. Limited quantities. Minch & Lyons, 2711 Virginia Court, Ft. Worth, Texas.

FAN BELT DRIVE A.C. GENERATOR FOR AUTO PA. \$5.00. J. Orslyn Kennan, Wisconsin.

WANTED—FOR CASH—AMATEUR RECEIVER. Latine, 293 Martense Street, Brooklyn, New York.

SELL CRYSTAL MICROPHONES. NON-DIRECTIONAL. eight-ball model. Brand new latest factory product. \$8.00. White Sound Studio, 151 West 63rd Street, New York, N. Y.

FOR HARD-TO-GET RADIO PARTS. EQUIPMENT. meters, accessories, thermo-couples and repairs. B. D. Heller, 2374 Webster Avenue, New York.

SALARIED POSITIONS

OUR SYSTEM OF SEARCHING FOR SALARIED POSITIONS, hiding your identity, increases your salary commensurate with training and experience, and with definite results. Write: Executive's Promotion Service, 300 B Street, S.E., Washington, D. C.

SONG POEM WRITERS

WANTED ORIGINAL POEMS, SONGS, FOR IMMEDIATE consideration. Send poems to Columbian Music Publishers, Ltd., Dept. P69, Toronto, Can.

SONGWRITERS! MELODY FOR WORDS \$1.00. Little, 215 Mason Theatre, Los Angeles, California.

WIND ELECTRIC PLANTS

BUILD WIND LIGHT PLANTS. COMPLETE PLANS and valuable catalog 10c. Welders, electric fences. Lelaj Manufacturing, 451 Lelaj Building, Minneapolis, Minn.

- One Browning Labs. bakelite antenna strip;
- One Browning Labs. drilled black-crinkle panel;
- One Browning Labs. drilled cadmium-plated chassis;
- Two Browning Labs. I.F. transformers, 456 kc., T1;
- One Browning Labs. I.F. transformer, 456 kc., T2;
- One R.F. choke, 2 1/2 mhy.;

RESISTORS

- One I.R.C. resistor, 400 ohms, 1/2-W., R1;
- Three I.R.C. resistors, 0.1-meg., 1/2-W., R2, R7, R13;
- Four I.R.C. resistors, 1,000 ohms, 1/2-W., R3, R6, R8, R9;
- Two I.R.C. resistors, 0.5-meg., 1/2-W., R4, R14;
- One I.R.C. resistor, 50,000 ohms, 1/2-W., R5;
- Two I.R.C. resistors, 1.0-meg., 1/2-W., R10, R12;
- One I.R.C. potentiometer, type 11-133, 0.5-meg., 1/2-W., R11;

CONDENSERS

- One Tobe Deutschmann paper condenser, 0.1-mf., 400 V., C1;
- Eight Tobe Deutschmann paper condensers, 0.05-mf., 400 V., C4, C5, C6, C7, C8, C10, C11, C13;
- One high-Q stabilized low-loss mica condenser, 0.002-mf., C2;
- One high-Q stabilized low-loss mica condenser, 100 mmf., C3;
- One mica condenser, 100 mmf., C9;
- Two mica condensers, 0.001-mf., C12, C14;

MISCELLANEOUS

- One Wright-DeCoster speaker with 8,000-ohm transformer;
- Three Raytheon 1N5G tubes;
- One Raytheon 1A7G tube;

More FOR YOUR MONEY!

... with ARCTURUS TUBES and the ARCTURUS EQUIPMENT DEAL!

Modern shop and test equipment will materially increase your sales and service profits—help keep them steady in good times and bad! That's why the ARCTURUS EQUIPMENT DEAL was devised. It is the fairest, most practical plan ever offered whereby you can obtain the modern equipment you need to beat your toughest competition ... at almost NO COST!

The ARCTURUS EQUIPMENT DEAL makes it easy! LOWER Down Payments ... LOWER Tube Requirements ... Tubes at Standard Prices—not one cent added to absorb the cost of the equipment ... IMMEDIATE DELIVERY of the units you select ... an amazingly wide choice of the very newest models!

New Equipment ... at almost NO COST!

Take advantage of the liberal ARCTURUS dealer policy—a policy that gives dealers and servicemen MORE FOR THEIR MONEY than ever before! Sell Radio's most complete tube line—the finest engineered tubes on the market today. Use the sales pulling ARCTURUS DEALER HELPS to bring new and old customers into your store again and again. And best of all, let your purchases of ARCTURUS TUBES pay for the valuable modern shop and test equipment you need. Get the facts! Let us show you how the Arcturus Deal brings this equipment within easy reach—practically free! ... how it actually gives you a Two-Way Profit on every tube!

MAIL THE COUPON TODAY!

"Go
ARCTURUS"

FOR GREATER PROFITS

ARCTURUS RADIO TUBE CO., Newark, N. J. C-13
Without cost or obligation on my part, send my copy of the Arcturus Dealer Helps folder and details of your Equipment Deal.

Name

Street

City State

I am a dealer I am a serviceman

My Jobber is

For convenience, paste coupon on penny postcard.



It answers all your CONDENSER QUESTIONS

- New AEROVOX Capacity and Resistance Bridge provides most accurate means outside best-equipped laboratories.
- Thoroughly tests all types of condensers for capacity, power factor, insulation resistance, leakage, etc.
- Also provides other capacity and resistance measurements, variable power supply, vacuum-tube voltmeter, precision meters, etc.
- Ask your AEROVOX jobber to show you this extraordinary instrument. Ask to see the manual. Or write us direct for literature.

AEROVOX

CORPORATION

70 Washington St. : : : Brooklyn, N. Y.

IN CANADA: AEROVOX CANADA, Limited, Hamilton, Ont.

CORRECTION

On pages 337 and 338 of the December, 1938, issue of Radio-Craft there appeared (respectively) a schematic and pictorial diagram which erroneously showed a dead short across the 115-volt line. Sections A and B on the diagram below show exactly where the error occurred. The arrows point to the wires which now properly "jump" instead of connect. Our thanks to William Hansen of Niles, Michigan, who was first to point out the error. We are sorry.

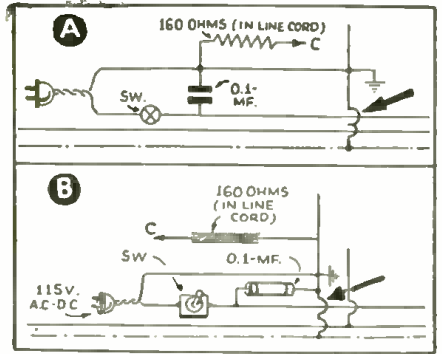

Please Say That You Saw It in RADIO-CRAFT

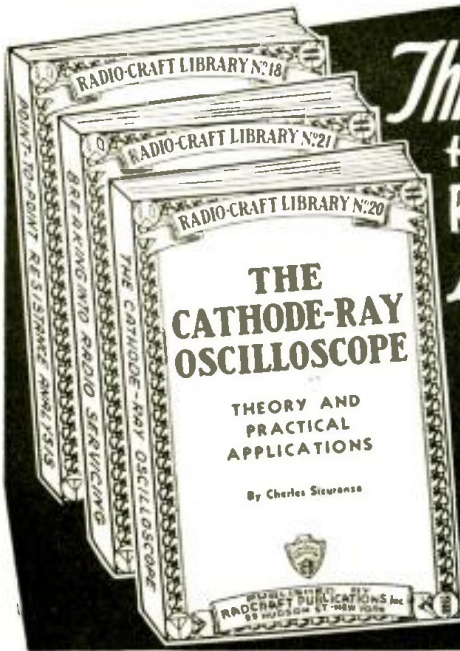

Three NEW Books
HAVE BEEN ADDED TO
RADIO'S MOST COMPLETE
Low-Priced LIBRARY
EACH VOLUME 50¢
The New Titles -
POINT-TO-POINT RESISTANCE ANALYSIS
BREAKING INTO RADIO SERVICING
THE CATHODE-RAY OSCILLOSCOPE

MAKING THE SERVICEMAN'S TEST UNIT—THE "SUPER-GENO-SCOPE"

(Continued from page 409)

- Two Sprague, 0.25-mf., 200 V., C32, C33;
- One Aerovox, 0.1-mf., 200 V., C34;
- One Solar, 300 mmf., C37;
- One Solar, 100 mmf., C39;
- One Solar, 50 mmf., C41;
- One Sprague, 0.01-mf., 400 V., C45;
- One Sprague, 0.15-mf., 400 V., C47;
- One National variable, type TMS-250, 250 mmf., C49.

RESISTORS

- Two I.R.C., 1 meg., 1/2-W., R1, R2;
- One I.R.C. variable, type A, 10,000 ohms, R3;
- One I.R.C., 6,000 ohms, 1/2-W., R4;
- Three I.R.C., 50,000 ohms, 1/2-W., R5, R6, R9;
- Two I.R.C., 0.25-meg., 1/2-W., R7, R27;
- One dual control, type LL, 0.1-meg., R8;
- One I.R.C., 15,000 ohms, 1/2-W., R9;
- One I.R.C., 10,000 ohms, 2 W., R10;
- One I.R.C., 20,000 ohms, 2 W., R11;
- One I.R.C., 15,000 ohms, 2 W., R12;
- One I.R.C., 0.5-meg., 1/2-W., R13;
- One I.R.C., 0.25-meg., 1/2-W., R14;
- One I.R.C., 50 ohms, 1/2-W., R15;
- One I.R.C., 150 ohms, 1/2-W., R16;
- One I.R.C., 0.1-meg., 1/2-W., R17;
- One I.R.C. variable, 25,000 ohms, R18;
- One I.R.C., 1,000 ohms, 1/2-W., R19;
- One I.R.C., 6,000 ohms, 1/2-W., R20;
- Two I.R.C., 300 ohms, 1/2-W., R21, R28;
- One I.R.C., 100 ohms, 1/2-W., R22;
- Two I.R.C., 10,000 ohms, 1/2-W., R23, R29;
- One I.R.C., 35,000 ohms, 1/2-W., R24;
- One I.R.C., 30,000 ohms, 1/2-W., R25;
- One I.R.C. variable, 20,000 ohms, R26.

SWITCHES

- One Yaxley switch plate for R8, Sw.1;
- One I.R.C. S.P.D.T. switch plate for R3, Sw.2;
- One Yaxley, 3 poles, 11 contacts, with extended rear shaft coupled to R26, Sw.3;
- One Yaxley, 4 poles, 5 contacts, 2-deck, Sw.4;
- One Yaxley, S.P.3 T., Sw.5;
- One Yaxley, 6-T. (2 make and 1 brake contact), Sw.6.

MISCELLANEOUS

- One power transformer (secondary No. 1, 650 V., c.-t.; No. 2, 6.3 V., 2 A.; No. 3, 5 V., 2 A.), T;
- One Wholesale Radio Service Co. filter choke, 30 hys., 450 ohms, L1;
- One midget push-pull transformer (1 grid lead and center-tap tied), L2;
- One RCA 80 rectifier tube, V1;
- Two RCA 6J7 metal tubes, V2, V3;
- One RCA 6K8 metal tube, V4;
- One RCA 6C5 metal tube, V5;
- Four Eby 8-prong sockets, V2, V3, V4, V5;
- One Eby 4-prong socket, V1;
- Three American Radio Hardware Co. auto antenna connectors, J8, J9, J10;
- Three Crowe dials, No. 263, 0-100, 1-3/8 ins. dia.;
- One Crowe dial, No. 292, 0-100, 4 ins. dia.;
- Dials: Mod., Band, Audio Selector, made to order;
- Three Crowe knobs with pointer, No. 284;
- One knob, No. 283, 2-1/16 ins. dia. (for Audio Selector).

Part III will discuss the controls; and a succeeding part will describe the frequency modulator.

GET into the swing of reading more books on important radio subjects—it's the easiest, quickest and most inexpensive way to add to your radio knowledge. New titles, continually being added to the RADIO-CRAFT LIBRARY SERIES, keep you posted on new developments. Three timely books, titles shown above, are now ready covering radio's latest advances. Read them without delay. Each book is exceptionally low in price—fifty cents a volume, and contains 64 pages, with illustrations varying from 50 to 150. To order any books use the coupon below—clip and mail today. A special saving for you! ALL BOOKS ARE SENT POSTPAID TO YOU.

Here Are the Titles

- | | | |
|--|---|---|
| <p>Book No. 2
 MODERN VACUUM TUBES
 And How They Work with Complete Technical Data on All Standard and Many Special Tubes
 By ROBERT HERTZBERG</p> | <p>Book No. 10
 HOME RECORDING AND ALL ABOUT IT
 A Complete Treatise on Instantaneous Recordings, Microphones, Recorders, Amplifiers, Commercial Machines, Servicing, etc.
 By GEORGE J. SALIBA</p> | <p>Book No. 16
 PRACTICAL RADIO CIRCUITS
 A Comprehensive Guide to All Types of Radio Circuits for the Service Man, Constructor and Experimenter
 By DAVID BELLARE</p> |
| <p>Book No. 3
 THE SUPERHETERODYNE BOOK
 All About Superheterodynes How They Work, How to Build and How to Service Them
 By CLYDE FITCH</p> | <p>Book No. 12
 PUBLIC ADDRESS INSTALLATION AND SERVICE
 Modern Methods of Servicing and Installing Public Address Equipment
 By JOSEPH T. BERNSELY</p> | <p>Book No. 17
 SERVICING WITH SET ANALYZERS
 A Study of the Theory and Proper Applications of Modern Set Analyzers and Associated Apparatus
 By H. G. McENTEE</p> |
| <p>Book No. 6
 BRINGING ELECTRIC SETS UP-TO-DATE
 With Pentodes, Multi-Mus. Dynamic Speakers—Complete Information on How to Modernize A.C., D.C., and Battery-Operated Receivers
 By CLIFFORD E. DENTON</p> | <p>Book No. 13
 ABC OF AIR CONDITIONING
 An Accurate Simplified, Technical Review of the Fundamentals of This Latest Branch of Engineering, Including Servicing Data on Present-day Units
 By PAUL D. HARRIGAN</p> | <p>Book No. 18
 POINT-TO-POINT RESISTANCE ANALYSIS
 Theory—And Application of This Modern Test Procedure in Every-day Radio Service Problems
 By BERTRAM M. FREED</p> |
| <p>Book No. 8
 RADIO QUESTIONS AND ANSWERS
 A Selection of the Most Important of 5,000 Questions Submitted by Radio Men During the Course of One Year</p> | <p>Book No. 14
 POCKET RADIO GUIDE
 Handy Reference Book for Radio Men—Set Construction Articles—Audio Amplifier Circuits—Useful Radio Formulas and Data—Handy Short Cuts—Index to Important Articles Printed in Radio-Craft Magazine
 By N. H. LESSEM</p> | <p>Book No. 20
 THE CATHODE-RAY OSCILLOSCOPE
 Theory and Practical Applications
 By CHARLES SICURANZA</p> |
| <p>Book No. 9
 AUTOMOBILE RADIO AND SERVICING
 A Complete Treatise on the Subject Covering All Phases from Installing to Servicing and Maintenance
 By LOUIS MARTIN</p> | <p>Book No. 15
 ABC OF REFRIGERATION
 A Compendium of the Principles of Refrigerating for Service Men with a Detailed Listing of Defects and How to Overcome Them, with Hints on Setting Up a Service Shop
 By TRAFTON MASON</p> | <p>Book No. 21
 BREAKING INTO RADIO SERVICING
 Simple Instructions and Procedure for Starting a Profitable Radio Business of Your Own
 By ROBERT EICHBERG</p> |

RADCRAFT PUBLICATIONS, INC. • 99 HUDSON ST. • NEW YORK, N. Y.

CLIP COUPON — AND MAIL TODAY!

RADCRAFT PUBLICATIONS, INC., Dept. RC-139, 99 Hudson St., New York, N. Y.

I have circled below the numbers of books in the RADIO-CRAFT LIBRARY SERIES, which you are to send me POSTAGE PREPAID. My remittance of \$..... is enclosed at the cost of fifty cents for each book. (Stamps, checks or money orders accepted.)

Circle numbers wanted: 2 3 6 8 9 10 12 13 14 15 16 17 18 20 21

Name Address

City State

Send remittance by check, stamps or money order; register letter if you send cash or stamps.

Please Say That You Saw It in RADIO-CRAFT

TELEVISION KIT!

(Continued from page 399)

and while programs at the present time are experimental they continue to be presented with greater regularity. A total of 15 tubes, exclusive of the cathode-ray tube are employed. The various functions of these tubes are outlined in the schematic circuit, Fig. 1. Table I at the end of this article gives a complete list of operating voltages for all

the tubes for trouble-shooting the receiver if necessary. Two 6H6's are used.

Selling the receiver in kit form makes it possible to keep the complete cost below the \$100 mark. The price includes only the video receiver and power supply. A sound receiver is not included.

TABLE I
TERMINAL VOLTAGES
PRONGS

TUBE TYPE	1	2	3	4	5	6	7	8	CAP
1852 R.F.	0	X	0	X	2	164	0	292	
6K8 Mixer	0	X	260	224	X	X	0	4	-4
1852 I.F.	0	X	0	X	2	164	0	248	
1852 I.F.	0	X	0	X	2	160	0	248	
1852 I.F.	0	X	0	X	2	140	0	256	
6H6 2nd-Det.	0	X	X	X	X	X	0	-2	
1852 1st Video	0	X	0	-1½	G	160	0	210	
6V6G 2nd Video	0	X	84	108	X	X	0	X	
6H6 Synch. Sep.	0	X	86	86	X	140	0	X	
6F8G L.F.	0	X	390	196	52	396	0	196	50
6F8G H.F.	0	X	400	224	116	406	0	224	120
6L7G L.F.	0	X	52	140	X	X	0	8	X
6L7G H.F.	0	X	120	168	X	X	0	8	X
Cathode-Ray	0	-1338	-726	22	-1284	13	-1320	-1032	

All voltage measured with a 1,000 ohms/volt meter relative to chassis.

VALUES OF SCHEMATIC COMPONENTS (Fig. 1)

(Continued from page 399, Fig. 1)

Resistors (Continued)

- R41—25,000 ohms, 1 W.
- R42—0.15-meg., 1 W.
- R43—3,000 ohms, 1 W.
- R44—50,000 ohms, pot.
- R45—0.5-meg., 1 W.
- R46—50 megs., 1 W.
- R47—1,000 ohms, 1 W.
- R48—0.15-meg., 1 W.
- R49—25,000 ohms, 1 W.
- R50—2,000 ohms, 1 W.
- R51—3,000 ohms, 1 W.
- R52—0.1-meg., pot.
- R53—1 meg., 1 W.
- R54—1 meg., 1 W.
- R55—0.5-meg., 1 W.
- R56—50,000 ohms, pot.
- R57—0.2-meg., 1 W.
- R58—0.1-meg., 1 W.
- R59—0.35-meg., pot.
- R60—2.5 megs.
- R61—1 meg., pot.
- R62—1 meg., pot.
- R63—1,200 ohms, 10 W.
- R64—0.25-meg.

Condensers

- C1, C2, C3—120 mmf., 3-gang variable
- C4—0.05-mf., 200 V.
- C5—0.05-mf., 400 V.
- C6—0.05-mf., 200 V.

- C7—0.05-mf., 400 V.
- C8—100 mmf., mica
- C9—0.05-mf., 400 V.
- C10—0.05-mf., 200 V.
- C11—0.05-mf., 400 V.
- C12—0.05-mf., 400 V.
- C13—0.05-mf., 200 V.
- C14—0.05-mf., 400 V.
- C15—0.05-mf., 400 V.
- C16—0.05-mf., 200 V.
- C17—0.05-mf., 400 V.
- C18—0.05-mf., 400 V.
- C19—30 mmf., mica
- C20—0.05-mf., 400 V.
- C21—16 mf., 450 V.
- C22—0.05-mf., 400 V.
- C23—16 mf., 450 V.
- C24—0.05-mf., 400 V.
- C25—16 mf., 450 V.
- C26—0.1-mf., 400 V.
- C27—0.05-mf., 450 V.
- C28—16 mf., 450 V.
- C29—0.05-mf., 400 V.
- C30—16 mf., 450 V.
- C31—10 mmf., mica
- C32—0.005-mf., mica
- C33—16 mf., 450 V.
- C34—16 mf., 450 V.
- C35—0.002-mf., mica
- C36—0.002-mf., mica
- C37—0.1-mf., 1,000 V.
- C38—850 mmf., mica

- C39—16 mf., 450 V.
- C40—0.25-mf., 400 V.
- C41—0.25-mf., 1,000 V.
- C42—0.05-mf., 2,000 V.
- C43—0.5-mf., 400 V.
- C44—1 mf., 2,000 V.
- C45—1 mf., 2,000 V.
- C46—16 mf., 450 V.
- C47—16 mf., 450 V.
- C48—16 mf., 450 V.
- C49—0.05 mf., 400 V.
- C50—0.05-mf., 2,000 V.
- C51—0.25-mf., 200 V.

Miscellaneous

- L1—3 turns No. 16 wire, ½-in. inside dia.
- L2—3 turns No. 16 wire, ½-in. inside dia.
- L3—4 turns No. 16 wire, ½-in. inside dia.
- L4—12 mc., I.F.
- L5—12 mc.
- L6—12 mc.
- L7—12 mc.
- L8—120 microhy.
- L9—120 microhy.
- L10—55 microhy.
- L11—50 microhy.
- L12—300 hy., 2 ma.
- L13—2,000 hy., 2 ma.
- L14—1,000 hy., 10 ma.
- L15—30 hy., 150 ma.
- L16—2 turns No. 16 wire, ½-in. inside dia.
- T1—H.V. trans.
- T2—L.V. trans.

Additional data concerning the components listed above have been supplied to *Radio-Craft*. The power transformer has a high-voltage secondary rating of 1,500 V. The following condensers are wet electrolytics, 525 V. peak: C21, C23, C25, C28, C30, C33, C34, C39, C46, C47, C48. Con-

densers C37, C40, C41, C43 and C51 are tubular units. Condensers C42, C44, C45 and C50 are tubular oil-filled units.

This article has been prepared from data supplied by courtesy of Garod Radio Corporation.

SERVICING QUESTIONS & ANSWERS

(Continued from page 415)

ference. Also took the tuning condenser apart and cleaned the bakelite in solvent.

If there is anything I have overlooked please let me know as soon as possible. Another thing, the 0.1-mf. condensers were melted out of the I.F. coils. Resistance coupling was substituted for the input transformer; also tried raising the oscillator plate supply voltage as well as current.

(A.) Trouble such as you describe, in your letter, with regard to Majestic 20 receiver is due to the oscillator stage. First of all, check the oscillator coil for high-resistance leakage between windings, after disconnecting leads. There are 3 windings on the oscillator coil. No high-resistance or leakage indication should be obtained between windings.

Check the grid leak value for resistance change. Correct value is 100,000 ohms. Should oscillator coil and grid leak test OK, then substitute a 0.001-mf. mica condenser for the oscillator series condenser and readjust the padder condenser.

OPERATING NOTES

(Continued from page 416)

8 mf., 300-volt wet electrolytic condenser losing capacity. Replace with a dry 8 mf., 450-volt unit. This part was changed to a dry unit in later production.

W. T. HALLOWELL.

Serviceman for Idabel Maytag Company

Please Say That You Saw It in RADIO-CRAFT

Hundreds of VALUES!

SEND FOR WARDS 1939 RADIO CATALOG FREE!

You can't go wrong when you buy from Wards. Only the highest quality equipment can measure up to Wards rigid standards, and every article in Wards complete catalog is offered at "rock bottom" prices. Not only do you save money but you can pay for your equipment "As you use it" on Wards liberal Time Payment Plan. Highest Quality, Lowest Prices, Time Payments, Satisfaction or Your Money Back—all these are yours when you buy from Wards. Send for your copy of Wards 1939 Radio Catalog today!

LOWEST PRICES

EVERYTHING SOLD ON TIME PAYMENTS

- ★Nationally Advertised Standard Merchandise
- ★Amateur Transmitters, Receivers and Parts
- ★Servicemen's Test Instruments and Equipment
- ★Sound Systems of All Types
- ★Inter-Office Communications Systems

MONTGOMERY WARD

"9 GREAT MAIL ORDER HOUSES, 580 RETAIL STORES"

FREE! MAIL THIS COUPON NOW

Montgomery Ward & Co., Dept. RZ-22, Chicago, U.S.A.
Please send me Wards 1939 Radio Catalog at once.

Name

Address

City State

MAKE YOUR OWN "TALKIES"!

With MILES Patented "FILMGRAPH" a sound track can be recorded on the edge of any 16 mm. film, which converts your silent film and silent projector into Sound Apparatus without cost for recording and reproducing. 84 minutes of recording may be had (without pictures) on a 100 feet of 16 mm. film costing only 85c. Records made and played back instantaneously. Moderate initial cost—only cost.

MILES REPRODUCER CO., INC.
812 RC BROADWAY, NEW YORK, N. Y.

RADIO ENGINEERING

RCA Institutes offer an intensive course of high standard embracing all phases of Radio and Television. Practical training with modern equipment at New York and Chicago schools. Also specialized courses and Home Study Courses under "No obligation" plan. Catalog Dept. RT-39.

RCA INSTITUTES, Inc.
A Radio Corporation of America Service
75 Varick St., New York 1154 Merchandise Mart, Chicago

ALL ABOUT BALLAST AND RESISTOR "TUBES"

(Continued from page 413)

FREE- REAL ELECTROPLATING OUTFIT



Now
You Can **ELECTROPLATE**
Easily with a **BRUSH**

SOMETHING new for radio men—something which gives you the opportunity to make additional profits—or to improve your type of service. Here's an **ELECTROPLATING KIT** amazingly simple to operate—you just Electroplate with a Brush!

NOT A TOY!

You can electroplate for profit, hundreds of things in the household—ashttrays, fixtures, water faucets, worn brackets, door knobs, musical instruments, jewelry and silverware and other articles. It's an indispensable piece of equipment to you for plating articles in hotels, apartments, office buildings, medical and dental offices, factories, schools, laboratories, etc. Exactly the same outfit (but larger) is used professionally by electricians, radio service men, automobile repair shops, etc. Requires one single dry cell 1½-volt battery to operate.

And for radio work, you can electroplate tarnished receiver parts, escutcheons, contacts, worn radio parts and accessories, and display chassis. Put this **REAL ELECTROPLATING KIT** to use immediately—make it the most useful article in your shop or laboratory. And, you can get it absolutely **FREE** (except for slight mailing cost).

Send your subscription today to **RADIO-CRAFT** for One Year (12 issues) and receive absolutely **FREE** this **REAL ELECTROPLATING KIT**. New subscribers are accepted or you may extend your present subscription another twelve months under this offer. Mail your remittance of \$2.50 (plus 10c for shipping charge on kit) to the publishers of **RADIO-CRAFT** (Canada and foreign \$2.85). You will promptly receive your **FREE, REAL ELECTROPLATING OUTFIT** by return mail. Use the coupon below to order your subscription.

RADIO-CRAFT 99 Hudson St.,
New York, N. Y.

RADIO-CRAFT RC-139
99 Hudson Street, New York, N. Y.

Gentlemen: Enclosed you will find my remittance of \$2.50 for which enter my subscription to **RADIO-CRAFT** for One Year (12 issues). Send me promptly my **FREE, REAL ELECTROPLATING OUTFIT** (Canada and foreign \$2.85). In U. S. add only 10c additional to cover shipping charges on kit.

New Subscriber Extend Present Subscription

Name

Address

City State

(Send remittance by check, money order or unused U. S. postage stamps. Register letter if you send cash or stamps.)

Type No.	Current Rating	Voltage Drop	+Normal Use	Exchange with
98	0.98	30	h 3	9-20
100	1.0	30		
105	1.05	30		9-20
106	1.06	30		9-20
110	1.10	30		11-20
118				11-10
125				10-10
126				12-20
130	1.3	20		13-10
140R	0.30	42.3	m	
140-R4	0.30	42.3	m -1	
140R8	0.30	42.3	m -2	
150	1.5	20		15-10
155				
158				
165R	0.30	48.6	m	
165R4	0.30	48.6	m -1	
165R8	0.30	48.6	m -2	
185R	0.30	54.9	m	
185R4	0.30	54.9	m -1	
185R8	0.30	54.9	m -2	
218				
313	1.3	30		13-20
314	1.4	30		14-20
315	1.5	30		15-20
415				11-10
425				
449				
460				
538	1.05	38		
838				
874	0.01-0.05	90	n	
876	0.70	40-60	h 4	
886	2.05	40-60	h	

*Line Resistor, not a tube.

+ See notes following for explanation.

TABLE I

The ballast- and resistor-"tube" symbols shown at the top of pages 412 and 413 are identified with their respective tubes in Table II as follows:

[A]—1-A-5, 2-A-5, 2H-5, 3-150, 3-220, 3-A-5, 3H-220, 4-220, 4-A-5, 4H-5, 4H-220, 5-16, 5-150, 5-220, 5-A-5, 5H-5, 5H-220, 6-20, 6-A-5, 7-20, 7-150, 7-A-5, 8-A-5, 9-20, 9-150, 9-A-5, 10-10, 10-A-5, 10V10, 11-10, 11-20, 11-150, 11-A-5, 12-20, 13-10, 13-20, 13-A-5, 14-20, 14-A-5, 15-10, 15-20, 18-10, 20-A-5, 22-10.

[B]—1-1, 1A1, 1B1, 1C1, 1D1, 1E1, 1F1, 1G1, 1J1, LH-1, GM-1, 2, 2H-1, 3, 3-1, 3-40, 3H-1, 4, 4-1, 5, 5-1, 5E1, 5H-1, 6, 6-1, 6AA, 6H-1, D6-1, 7, 7-1, 7H-1, 8, 9, 10AB.

[C]—1A2, 1B2, 1C2, 30, 31, 52.

[E]—46A1, 46B1.

[F]—9V10, 70, 90.

[G]—42A1, 42A2, 42B2, 49A1, 49A2, 49B2, 55A1, 55A2, 55B2.

[H]—140R, 140R4, 140R8, 165R, 165R4, 165R8, 185R, 185R4, 185R8.

[I]—038, 98, 100, 105, 106, 110, 118, 125, 126, 130, 150, 155, 158, 218, 313, 314, 315, 415, 425, 449, 460, 538, 838.

[J]—874.

Screw—876, 886.

NOTES ON NORMAL USE

(a) For use in operating 2.0-volt tubes from Air-Cell or 3-volt drycell batteries. When used this way, no other resistor is necessary in the filament circuit, and none should be used. When operating from a 2-volt storage cell the ballast tube should be shorted out of the circuit. The voltage drop of this group of ballast tubes is sometimes shown as 1.0 volt, although the actual drop is as shown in this table; depending on the voltage of the battery.

(b) For use in receivers designed for operation on 110 volts, and are usually connected in series with the primary of the power transformer.

(c) For use in place of the resistor type of line cord in A.C.-D.C. receivers operated from 110-volt lines.

(d) Used to operate A.C.-D.C. receivers from a 220-volt line.

(e) Used in place of those in group (b) when operating 110-volt receivers from 150-volt lines.

(f) For use when operating 110-volt receivers from 220-volt lines.

(g) For use with sets designed to operate from 32-volt lighting plants.

(h) For use in the primary circuit of receivers designed for use with a ballast in series with the transformer primary. The primary of the transformer should be designed for the following voltages:—

h1.....100 volts h3.....85 volts
h2.....95 volts h4.....65 volts

(k-k1) These types are for use in Majestic receivers. Types marked (**) are manufactured by several manufacturers of tubes. The types marked k1 are designed to replace the fixed-resistor type line ballasts used as original equipment in Majestic receivers.

(m) To replace the resistor cord in A.C.-D.C. receivers and do not have tap on resistor shown in diagram.

(m-1) Same as above except that they have a tap for operating one 6-8 volt pilot light.

(m-2) Same as group (m) except tap for operating two 6-8 volt pilot lamps.

(n) This type is a voltage regulator rather than a ballast; and is used in some of the older receivers to provide constant voltage from a 90-volt tap of the power supply.

Table III

R.M.A. Tube No.	Ballastron Equivalent	Cut Strip at Colors (R-Red, B-Blue, Y-Yellow)	Unscrew Pins and Clip Off Screws
85-A	Type B	R-B-Y	No. 2 and 8
79-A	Type B	R-B	No. 2 and 8
73-A	Type B	R-Y	No. 2 and 8
67-A	Type A	R-B-Y	No. 2 and 8
61-A	Type A	R-B	No. 2 and 8
55-A	Type A	R-Y	No. 2 and 8
49-A	Type A	R	No. 2 and 8
42-A	Type A	B-Y	No. 2 and 8
36-A	Type A	B	No. 2 and 8
30-A	Type A	Y	No. 2 and 8
24-A	Type A		No. 2 and 8
K-67-B	Type A	R-B-Y	No. 2
K-61-B	Type A	R-B	No. 2
K-55-B	Type A	R-Y	No. 2
K-49-B	Type A	R	No. 2
K-42-B	Type A	B-Y	No. 2
K-36-B	Type A	B	No. 2
K-30-B	Type A	Y	No. 2
K-24-B	Type A		No. 2
L-73-B	Type B	R-B-Y	No. 2
L-67-B	Type B	R-B	No. 2
L-61-B	Type B	R-Y	No. 2
L-55-B	Type B	R	No. 2
L-49-B	Type B	B-Y	No. 2
L-42-B	Type B	B	No. 2
L-36-B	Type B	Y	No. 2
L-30-B	Type B		No. 2
K-79-C	Type B	R-B-Y	No. 2
K-73-C	Type B	R-B	No. 2
K-67-C	Type B	R-Y	No. 2
K-61-C	Type B	R	No. 2
K-55-C	Type B	B-Y	No. 2
K-49-C	Type B	B	No. 2
K-42-C	Type B	Y	No. 2
K-36-C	Type B		No. 2
K-67-D	Type A	R-B-Y	None
K-61-D	Type A	R-B	None
K-55-D	Type A	R-Y	None
K-49-D	Type A	R	None
K-42-D	Type A	B-Y	None
K-36-D	Type A	B	None
K-30-D	Type A	Y	None
K-24-D	Type A		None
L-67-D	Type B	R-B-Y	None
L-61-D	Type B	R-B	None
L-55-D	Type B	R-Y	None
L-49-D	Type B	R	None
L-42-D	Type B	B-Y	None
L-36-D	Type B	B	None
L-30-D	Type B	Y	None
L-24-D	Type B		None

Table IV

Maker of Set	Part No.	Choose Tube	Remove Pins	Cut Strip
Emerson	21R224	B	2	R-Y
Emerson	21R215	B	2	R
Emerson	30R211	B	NONE	B
Crosley	W13357	A	2	R
RCA	RC294 or 135K1	A	2	R
RCA	RC300 or 95K2	B	2	Y
RCA	RC315 or 190K1	A	2 & 8	R-Y
DeWald	8598	B	2	R
Fada	115-1	A	2 & 8	R

This article has been supplied from data supplied by courtesy of National Union Radio Corp.

Please Say That You Saw It in **RADIO-CRAFT**

THIS HOME—WIRED FOR RADIO

(Continued from page 397)

to serve the entire home—radio in each room! The development of motor-tuned receivers, efficient permanent-magnet dynamic speakers, pushbutton tuning and the like, makes the present time ripe for built-in radio.

YEARS TO PAY

Most important of all, today, the payments for such a built-in radio system may be strung out over a longer period of time than even the most liberal of installment houses would allow. Yet the dealers and jobbers selling the apparatus get their money almost immediately.

How? Very simple. Since the radio installation is an integral part of the house and its cost, it is possible therefore, that it may be paid-for over a period of from 20 to 25 years (after an initial down payment of 10 per cent) under the F.H.A. plan of government-insured mortgages. (*Radio-Craft* is awaiting a ruling by Stewart McDonald, chief of the Federal Housing Administration [F.H.A.], on this plan.)

Conservative "stand-patters" might ask, "Why radio in every room?" To them the answer is, "Why electric lights in every room?" Why not all the light in one room and if one feels like reading, retire to that room; or why not all the heat radiators in one room? Imagine how much plumbing and wiring we'd be saving! But do we do it? No! We like our conveniences! As does everyone.

And so with radio! Why concentrate all the radio entertainment in one room? Let's distribute it throughout the home along with the other utilities; and let's do it when it's most convenient—at the time of construction.

MASTER SET "KEY" UNIT

Now a few words about the installation itself, what it comprises and what it does. First of all, the cost of the installation is entirely dependent upon the type of master radio set used. Any motor-tuned receiver can be employed. If you prefer a high-fidelity job you naturally have to pay more. This in turn increases the overall cost of installation. The remote, permanent-magnet dynamic loudspeakers, however, can be used with any type of motor-tuned receiver so that their cost as well as that of the remote pushbutton switches and other small incidentals is fixed. The only variable is the receiver. (A complete list of equipment which we are using will be given at the end of Part II of this series of articles.)

"What guarantee have I that a set purchased today may not be obsolete tomorrow?" you may ask. Well, for that matter, what about the car bought this year—will it be "in style" tomorrow? Like a good car, a good radio set will be usable for many years. However—and bear this in mind—the radio set is only a part of this "system" and if desired, in later years, may be replaced by a different radio set, without changing the wiring and speaker system built into the home.

Remember too that a high-quality radio receiver brings out all that is in a radio or phono program; hence, if the set is later replaced, its cost has been returned many-fold, meanwhile, in entertainment. Of course some people are content with mediocre radio program reception, caring little for the symphonies, operas, and other musical gems that grace the airways today, but it is nice to be able to offer to guests in

Step Up!
Equip
Yourself for
More Business
the
NATIONAL
UNION
Way

Write for Details and
Name of Nearest
Distributor

NATIONAL UNION
RADIO CORP.
NEWARK, N. J.



Thousands of
Aggressive Service Engineers Make More
Money by getting instruments the N.U. Way

Radio owners will naturally turn to the service engineer who builds himself a reputation for having the latest things in test equipment so that he can service radios quickly and do a 100% satisfactory job. Remember on the National Union plan you don't have to put up the amount of money which would normally be required if you were to go out and buy the modern equipment you want. Through National Union you earn the equipment through every day purchases of National Union Radio tubes and condensers.

- Here's all you do:
1. Select the equipment you want.
 2. Sign a National Union tube and/or condenser purchasing agreement.
 3. Place a small deposit which will be refunded to you as a merchandise credit when your purchasing agreement is completed.
 4. Order a small quantity of National Union tubes and/or condensers at the time you sign the agreement.
 5. Apply your regular monthly purchases of tubes and condensers against the requirements of the contract.

SEE THE BIG 102-PAGE MANUAL AT YOUR JOBBER

the new home, radio (and phonograph) reproduction the tone-quality of which pays a subtle compliment to the judgement of the home owner.

And now for more detailed information regarding the recommended equipment.

In the livingroom of the Model Home is located the master receiver—an RCA-Victor model U-130 combination automatic victrola and radio. Built into a wall of each room, about 5½ ft. from the floor, is an RCA permanent-magnet dynamic speaker, a Mallory-Yaxley 8-button pushbutton switch, and a T-pad volume control. The master receiver can be turned on and off from any room. If turned on in one room it can be turned off in any of the others. The receiver can also be tuned from any room.

This tuning is accomplished merely by pushing the proper buttons on the speaker grille (the speaker, tuning and volume controls are all mounted behind this one grille).

Further, the remote speakers can be turned on either individually or all at a time, as desired. Their volume settings are individually controllable so that while one might be going full-blast in one room any or all of the others can be cut down to a whisper. Yet the volume of one does not affect either the volume or frequency response of any of the others.

Now let's go through the entire process of working this system.

(Continued on page 445)

WE WANT USED TEST EQUIPMENT and METERS!

Have large order for European Shipment. Need used Radio Test Equipment and Meters. Will allow trade-in toward purchase of any instrument in our new Teco line. Write immediately indicating make of instrument or meter. (Must be in working condition—appearance or age unimportant.)

TEST EQUIPMENT CO. OF AMERICA
139 Cedar St., Dept. XT, New York, N. Y.



Do yourself a good turn and let that good old scout "Old Man Centralab" help you with his ADASHAFT kit housed in a swell metal box, hinged, contains ten Midget Radiohms, five types of attachable shafts, etc. This kit will enable you to do some mighty fine "deeds" for more than 400 different makes of receivers—actually thousands of different models. See your jobber.



MIDGET RADIOHM
ADASHAFT
KIT

Centralab
MILWAUKEE WISCONSIN

Please Say That You Saw It in RADIO-CRAFT

A New Policy!

FREE INSPECTION PLAN - -

You can buy any Gernsback Manual on Three Days' Approval

Perhaps you're new in Radio—or probably, in previous years you missed one of the Gernsback OFFICIAL RADIO SERVICE MANUALS. This is your opportunity to buy any edition you might need—get it in a way differently than ever before offered. Under a new policy—FREE INSPECTION PLAN—you can buy any Gernsback Manual on Three Days' Approval. There are thirteen Manuals and books from which to choose—every man in Radio should take advantage of this privilege.

Here Is How It's Done!

Order any GERNSBACK MANUAL illustrated and described on this page—the publishers will ship it to you immediately POSTPAID. When it reaches you, inspect its contents. If, after three days' inspection, you decide to keep the Manual, mail your remittance to the publishers. If the volume proves unsuitable, return it postpaid.

This plan is simple—there's no mystery or red tape—it gives you every opportunity to inspect the Manual of your selection. It costs you only a few cents return postage if you decide not to keep it.

Latest Volume 7 Manual Included

Volume 7 of the OFFICIAL RADIO SERVICE MANUAL—the edition which stamped the Radio industry this past year because it was published in a new way—in twelve monthly installments, is included under this new policy. This volume is now complete—twelve installments, totaling 1,800 pages, are bound in a hardcover binder and just packed with information you need today—and in the years to come. The coupon below gives you the privilege of inspecting this Manual also before you buy it.

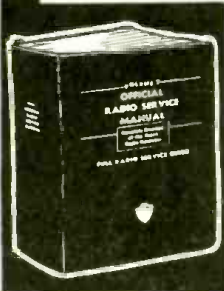

★ **VOLUME 7** ★
Newest of GERNSBACK MANUALS contains schematic diagrams and service data on 1936-37-38 receivers. More up-to-date than any service guide published, 1,800 pages of material which radio men use every day. Wiring diagrams of over 1,200 different manufactured sets. Over 3,000 different illustrations. Bound in hard-loseleaf covers—mechanism permits pages to be removed and replaced. Size—9 x 12 inches.
PRICE \$10.00



★ **1936 MANUAL** ★
Contains 1,200 pages (over 2,500 illustrations) packed with service data of 1935-36-37 sets. Diagrams of over 1,500 receivers. Shows speaker connections, power transformer connections. Alignment procedure included with diagrams. Operating voltages for over 80% of sets are recorded. Assembly diagrams show relationship of separate units to each other. Size—9 x 12 inches; hard cover, looseleaf binder.
PRICE \$7.00



★ **1935 MANUAL** ★
An authentic radio service guide of over 1,000 pages with more than 3,000 illustrations—contains schematic diagrams of 1934-35 receivers. Features many old sets never previously described; early all-wave and short-wave sets, auto-radios, midjet and cigar-box receivers. Includes data on P.A. amplifiers, servicing instruments, tube information and **FREE QUESTION AND ANSWER SERVICE.** Size—9 x 12 inches; flexible, looseleaf covers.
PRICE \$7.00

★ **1935 AUTO-RADIO MANUAL** ★
OVER 240 PAGES
OVER 500 ILLUSTRATIONS
Looseleaf Binder—Flexible Covers
PRICE \$2.50



★ **1934 MANUAL** ★
Contains over 400 pages—over 2,000 illustrations. The schematic diagrams cover 1933-34 receivers. Features voltage readings, I.F. transformer values in superhets, valuable tube data and **FREE QUESTION AND ANSWER SERVICE.** A handy index makes it easy to find any information on service problems. Master index includes diagrams published in previous MANUALS. Size—9 x 12 inches; flexible, loose-leaf covers.
PRICE \$3.50

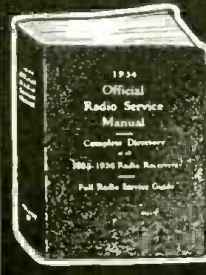

★ **1933 MANUAL** ★
This 700-page Manual, with over 2,000 illustrations, contains page after page of operating notes—schematics showing location of parts on chassis—values of I.F. peaks, resistors and condensers. A complete section on construction of various types of test equipment, plus money-making ideas for radio men. Includes auto-radio installation and servicing. Size—9 x 12 inches; flexible, loose-leaf covers.
PRICE \$5.00



★ **1932 MANUAL** ★
This Manual contains a full radio service guide of 1931-32 receivers. With over 1,000 pages and over 2,000 illustrations, it features a step-by-step analysis in servicing a receiver—chart showing operation of vacuum tubes—schematic diagrams with color coding indicated—commercial short-wave receivers and adapters, and servicing public address equipment. Size—9 x 12 inches; flexible, looseleaf covers.
PRICE \$5.00

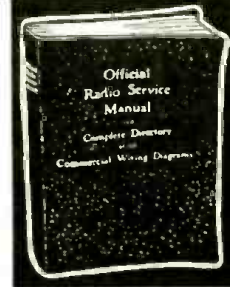

★ **1931 MANUAL** ★
The first of the famous GERNSBACK MANUALS—contains all available wiring diagrams of nearly every receiver manufactured a year ago. This particular edition contains 650 pages (including supplements) with over 1,500 important diagrams. Most valuable to radio men is the **RADIO SERVICE COURSE** published in this edition. Size—9x12 inches; flexible, looseleaf covers.
PRICE \$4.50
including supplements.



OFFICIAL RADIO SERVICE HANDBOOK
Here's the sensational book on servicing. Covers over 500 topics. Contains a special section of 250 pages of Operating Notes. The book covers: Circuit Theory and Analysis; Modern Servicing and Test Equipment; Practical Trouble Shooting; Specialized Receiver and Installation Data; Modernization and Conversion Data, etc. Over 1,000 pages—over 1,000 illustrations; hard covers. Size 6 x 9 inches.
PRICE \$4.00

● This Policy Includes — OFFICIAL REFRIGERATION SERVICE MANUAL (Volume 1) — \$3.00
OFFICIAL REFRIGERATION SERVICE MANUAL (Volume 2) — \$5.00
OFFICIAL AIR CONDITIONING SERVICE MANUAL — \$5.00

How To Get Any Manual You Need!

After you have definitely decided which Manual you want, fill in completely the coupon at the right. Clip it to your letterhead or paste on a penny post card and mail to the publishers. In a few days your Manual will reach you—Don't lose time—send coupon, TODAY, to

RADCRAFT PUBLICATIONS, Inc.
99 Hudson Street New York, N. Y.

RADCRAFT PUBLICATIONS, Inc. RC-139
99 Hudson Street, New York, N. Y.
Please send me, POSTPAID, _____ for three days' examination on approval. In three days I will remit to you the full cost of the Manual or book selected, or return the volume to you postpaid.
Name _____
Address _____
City _____ State _____
Name of company or employer _____
(This offer is good only in continental United States.)

Please Say That You Saw It in RADIO-CRAFT

ELECTRODYNAMIC SPEAKER EFFICIENCIES

THE Amateur and Serviceman are interested in 3 acoustic characteristics in modern dynamic loudspeakers. They are sensitivity, distortion, and cut-off frequency.

The sensitivity is the intensity of sound produced by the loudspeaker for a certain amount of electrical energy fed into the input. High sensitivity is obtained by causing an intense magnetic field in the air gap in which the voice coil works; having the voice coil close to the field core (with a clearance of not more than a few thousandths of an inch), and by designing the reproducer with a center core leg and shell of high-grade magnetic steel. The efficiency of a good-grade speaker of this type is about 5%. The cheaper grades vary from 2 to 4%.

The amount of distortion is the difference between the electrical wave fed into the loudspeaker and the sound wave produced by the speaker. The distortion is kept low by having properly filtered current in the field, thus keeping out a 60- and 120-cycle hum; having the cone properly centered and constructed of the proper material; and, having an intense magnetic flux in the air gap. Of course the speaker must not be overloaded at any time or distortion will result.

The cut-off frequency constitutes points on the high and low frequencies above which and below, the speaker will not produce sound waves efficiently. The average 8-inch speaker will reproduce notes as low as 30 cycles and as high as 6,000 cycles.

The human ear often responds to a frequency range of from 20 to 20,000 cycles. It has been proven by tests that 90% of spoken words may be understood by using a frequency range from 500 cycles to 5,000 cycles, though for good reproduction of music a frequency range from 80 cycles to 10,000 cycles is necessary.

This shows that the speaker used in the medium-priced radio set will not allow high-fidelity reception. It is very easy to build a radio

receiver that will handle any necessary frequency range. It may be done by using resistance-capacity coupling in the audio circuit; but with the type of speakers in use today it is useless to build such a circuit.

When speakers that are 50 to 80% efficient, become a commercial possibility, it will change the entire field of radio.

A 50%-efficient speaker could be connected directly to a magnetic pickup and would deliver normal room volume!

CHOICE OF CATHODE-RAY TUBE SCREENS

ALTHOUGH the medium-persistence "green" cathode-ray tube pattern is generally used in standard oscilloscope practice, there are other screens available where the applications vary from normal requirements, so points out television engineer Allen B. du Mont.

For very rapidly-changing phenomena, there is the short-persistence "blue" screen, the image of which is so short-lived that there is no pickup of successive patterns to confuse the observer.

For the study of transient phenomena, particularly when comparisons are desired between them, there is the long-persistence "time delay" screen. The pattern traced by a single phenomenon remains on the screen for as long as a minute. If desired, several phenomena may be placed on the screen and compared. Also, the screen patterns may be readily photographed because of their persistency.

Finally, there is the medium-persistence "white" screen, which provides for black-and-white patterns that may be more desirable than the green or the blue for certain types of work.

The availability of these several kinds of screens should be borne in mind when planning cathode-ray tube equipment.

THIS HOME—WIRED FOR RADIO

(Continued from page 443)

HERE'S HOW IT WORKS

You get up in the morning; you go into the bathroom for your shave. If you like a little music, or the periodic radio time signals, you merely walk over to the speaker grille on which are located the 8 pushbuttons and volume control. WEA F is your favorite station, so you merely press the button under the tab WEA F. Immediately a small red bezel lights up, indicating that the set has gone on. The button must be kept depressed until the station comes on (a matter of a few seconds).

If instead of WEA F you decide you want WJZ you merely press the WJZ button until that station's program comes in. The volume is too low so you turn it up higher, or vice versa. To turn the set off you merely press the OFF button once. You needn't keep this button depressed.

When the set first comes on a pilot light behind the red bezels on the remote controls of each room lights up so that people in other rooms know that the system is in operation. If they wish, they may cut-in on the program by turning their volume control "up," automatically cutting-in the speaker in their particular room.

Additional speakers and remote controls can be wired up to the attic and down to the cellar where there is, or perhaps later might be added, a playroom or a bar.

AUXILIARY RECEPTION

It is not intended that this complete radio system preclude the use of any additional receivers in the home. There may be a young man in the family who likes to listen to football scores or the Uncle Don hour at a time when other members of the family prefer music. For him we suggest a separate midget receiver in his own room.

Or the lady of the household may keep her radio set going from morn to night. Most American housewives do these days. Obviously it would be impractical to keep a 12-tube set running all day. So for her we might have a midget receiver recessed into one of the kitchen cabinets.

The built-in radio system, mind you, will find its greatest use and comfort in the evening when the entire family is home or at times when guests are being entertained or parties, festivities, etc., are being held.

AUTOMATIC PHONOGRAPH

The automatic phonograph (a unit which will play seven 10-in. records or six 12-in. records automatically) may also be heard over the entire system, if so desired. The choice of a combination phono-radio as the master receiver makes the entire system most practical, especially for parties, for when no dance music is on the air the automatic phonograph can be used. And being that the radio set is a high-fidelity job, the records can be played with excellent fidelity of reproduction—an unexcelled source of enjoyable programs when "there's nothing good on the radio."

The "automatic" feature of this instrument, by which one phono record after another is played without anyone's attention, will be especially welcome during the dinner hour.

MERCHANDISING

Now let's look at it from the business point of view. Who is going to profit from this new field of built-in radio? We have already pointed out how the consumer profits.

Radio manufacturers will sell more receivers, more speakers and switches and (Continued on page 448)

Increase Your Sales and Profits

with

WRIGHT-DECOSTER SPECIALS



EXAMPLE
Model E 5 X S

5" electro dynamic
3000 OHM field
single 43 trans-
former

List Price
\$2.40

Is your distributor keeping you in touch with these fast selling items?

If not let us tell you about them. A note from you is all that is necessary.

WRIGHT-DECOSTER, Inc.

2251 University Ave., St. Paul, Minnesota
Export Dept.: M. Simons & Sons Co., New York
Cable Address: "Simonrice"

Readrite RANGER

Always UP-TO-DATE

COMPACT

NEW MODEL 432

only \$21.60

COMPLETE IN QUARTER-OAK CASE

TUBE TESTER
Checks All Types Radio Receiving Tubes

- Separate Plate Tests on Diodes and Rectifiers
- Neon Short and Leakage Tests
- Ballast Tube Continuity Test
- Uses Attractive Triplet Direct Reading Instrument 3" Size. (GDD-BAD) Scale.
- Line Voltage Adjustment
- New Improved Low Loss Switch

Suitable for counter or portable use. Sloping etched panel of silver and black. Also Available Model 431. **\$15.90**

Checks all receiving tubes. (No ballast test.) Tester uses dependable Readrite Meter. Quartered-Oak case same as for Model 432.

Write for Catalog—Section 116, College Drive

READRITE METER WORKS
BLUFFTON, OHIO

Please Say That You Saw It in RADIO-CRAFT

FOUR NEW 10¢ RADIO BOOKS!

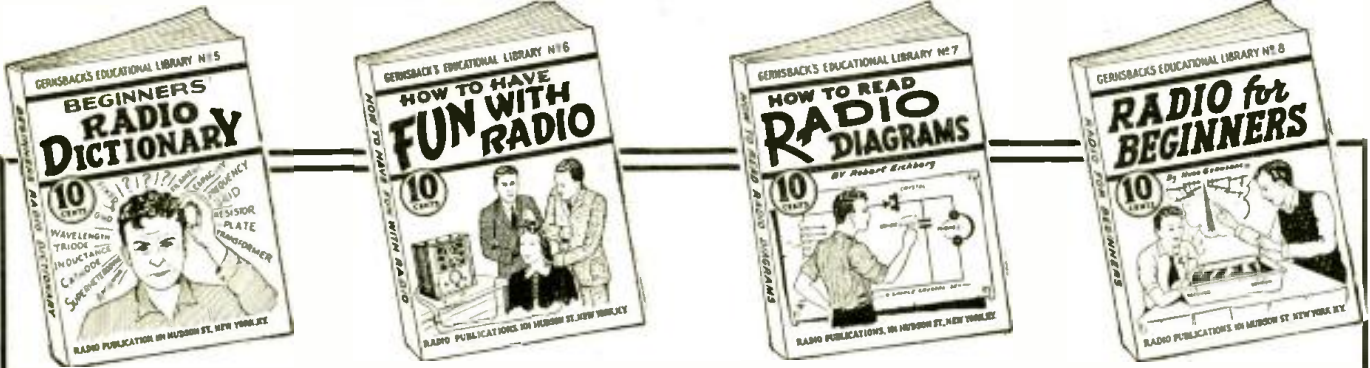

RADIO FANS EVERYWHERE—these little ten cent text books give you an excellent foundation for the study of radio. They are clearly written, profusely illustrated and contain over 15,000 words in each book. You'll be amazed at the wealth of information these volumes have. They are handy for review or reference books.

NO. 5—BEGINNERS' RADIO DICTIONARY

Are you puzzled by radio language? Can you define frequency? Kilocycle? Tetrode? Screen Grid? Baffle? If you cannot define these very common radio words and dozens of other, more technical, terms used in all radio magazines and instruction books, you need this book in your library. It's as modern as tomorrow—right up to the minute. It tells you in simple language just what the words that puzzle you really mean. You cannot fully understand the articles you read unless you know what radio terms mean. This is the book that explains the meanings to you. Can you afford to be without it, even one day longer?

NO. 8—HOW TO HAVE FUN WITH RADIO

Stunts for parties, practical jokes, scientific experiments and other amusements which can be done with your radio set are explained in this fascinating volume. It tells how to make a newspaper talk—how to produce silent music for deities—how to make visible music—how to make a "silent radio" unit, usable by the deafened—how to make toys which dance to radio music—sixteen clever and amusing stunts in all. Any of these can be done by the novice, and most of them require no more equipment than can be found in the average home. Endless hours of added entertainment will be yours if you follow the instructions given in this lavishly illustrated book.

NO. 7—HOW TO READ RADIO DIAGRAMS

All of the symbols commonly used in radio diagrams are presented in this book, together with pictures of the apparatus they represent and explanations giving an easy method to memorize them. This book, by Robert Fichtel, the well-known radio writer and member of the editorial staff of RADIO-CRAFT magazine, also contains two dozen picture wiring diagrams and two dozen schematic diagrams of simple radio sets that you can build. Every diagram is completely explained in language which is easily understood by the radio beginner. More advanced radio men will be interested in learning the derivation of diagrams, and the many other interesting facts which this book contains.

NO. 8—RADIO FOR BEGINNERS

Hugo Gernsback, the internationally famous radio pioneer, author and editor, whose famous magazines, RADIO AND TELEVISION and RADIO-CRAFT are read by millions, scores another triumph with this new book. Any beginner who reads it will get a thorough ground work in radio theory, clearly explained in simple language, and through the use of many illustrations. Analogies are used to make the mysteries of radio as clear as "2+2 is 4." It also contains diagrams and instructions for building simple radio sets, suitable for the novice. If you want to know how transmitters and receivers work, how radio waves traverse space, and other interesting facts about this modern means of communication, this is the book for you!

Other Titles in This 10c Book Series!

- No. 1—HOW TO BUILD 4 DIERLE SHORT-WAVE SETS
- No. 2—HOW TO MAKE THE MOST POPULAR ALL-WAVE 1- AND 2-TUBE RECEIVERS.
- No. 3—ALTERNATING CURRENT FOR BEGINNERS
- No. 4—ALL ABOUT AERIALS

Four other volumes in this ten-cent radio book series—each on a popular subject—are available. The titles are:

RADIO PUBLICATIONS, Dept. RC-139
101 HUDSON STREET, NEW YORK, N. Y.
Gentlemen: Please send immediately, POSTPAID, the book numbers circled below. I am enclosing cents—each book being 10c.

1 2 3 4 5 6 7 8

Send FREE listing of 48 new 10c publications.

Name

Address

City State

Remit by check or money order—register letter if you send cash or unused U. S. postage stamps.

MAIL COUPON TODAY!

BOOKS ARE ALL UNIFORM

Every book in the GERNSBACK EDUCATIONAL LIBRARY has 32 pages—with illustrations varying from 30 to 68 in number. Each title volume contains over 15,000 words. Positively radio's greatest book buys! If you do not think these books worth the price asked, return them in 24 hours and your money will be instantly refunded.

RADIO PUBLICATIONS
101 Hudson Street New York, N. Y.

THE SKIN-EFFECT TALKING LIGHTBEAM

(Continued from page 411)

face of the light filament and instead of heating the entire filament as heretofore, the current travels along the surface. Thus the filament may change temperature fast enough to transmit sound.

SKIN EFFECT

Skin effect is a phenomena of alternating currents. The maximum inductive reactance in a wire or filament is at its axis. In general the inductance offered to other filaments of current decreases as the distance from the axis increases. Thus the current is distributed so that it is greatest near the surface. The heat generated by this current is proportional to the square of the current. The heat is radiated from the surface, conducted to the cooler center and used in raising the temperature of the filament.

The high-frequency alternating current (radio-frequency) causes the skin effect, the modulation of this current varies the surface temperature of the filament so that the light varies with the modulation. The conductivity of the metal carries the surface heat toward the center of the filament when the modulated current is great, thus allowing the surface to cool more rapidly so the radiation may follow the modulated current down. This improves the audio response at high frequencies.

A curve was drawn to show the advantage due to skin effect. It was shown as a

percentage of the oscilloscope readings of a sine wave at some frequency compared with the reading at 768 cycles per second. This curve of the efficiency of lightbeam modulation was measured on an oscilloscope having its vertical sweep connected to the output of the receiver. The input to the oscilloscope was a beat-note oscillator connected to the transmitter.

A photoelectric cell is mounted in the focus of a parabolic reflector which may be made from an electric heater by removing the heating element. The particular heater purchased was selected after testing several because it concentrated rays from a distant light at a very small area. It is necessary that the rays focused by the parabola form a sharp-pointed cone of light which can get into the curved plate of the cell rather than hit on its outside edge.

Directly behind the cell is mounted a midget 0.01-mf. coupling condenser, C1; a 1-meg. resistor, R3, through which the cell receives its positive voltage and the 5-meg. resistor, R4, which is the grid resistor for the 1st tube. The shielding afforded by the metal reflector and the wire shield in front of it is enough for shielding these elements, however they might be further shielded to cut down A.C. hum by wrapping them in tinfoil and grounding the foil.

Similar phenomena have been developed before by means of high-voltage equipment

and the use of cathode-ray and neon lights, but never before with simple equipment including the use of a "nickel" (5c) battery lamp.

The 12-meter grid coil is wound with 18 turns of No. 14 enamel-covered wire on an air core 2x½-in. inside dia. The 12-meter plate coil has 12 turns of E.C. wire on a 1½x¾-in. dia. air core; the coupling to the Mazda-lamp circuit is accomplished by means of a single turn of No. 14 E.C. wire around the center of the plate coil.

One position of the S.P.D.T. switch connects the mike through a 4½ V. mike battery, the other cuts the battery out so a low-impedance phono pickup may be used. The single-button carbon mike used had low impedance.

LIST OF PARTS

TRANSMITTER

- One American type SB single-button carbon microphone, hand type;
- One Yaxley No. 75 phone plug;
- One Yaxley No. 1 phone jack;
- One H&H S.P.D.T. toggle switch;
- One U.T.C. No. CS6 microphone input transformer;
- One Aerovox No. PR25 condenser, 10 mf., 25 V.;
- One Cornell-Dubilier electrolytic condenser, 4 mf., 450 V.;
- One Yaxley No. M25MP volume control potentiometer, 0.25-meg.;

Please Say That You Saw It in RADIO-CRAFT

CASH IN ON YOUR SPARE TIME!

300 WAYS TO MAKE MONEY

ONLY **25c** Per Copy



68 PAGES

MAIL ORDER MAKERS TESTED MONEY MAKERS BUSINESS SECRETS SUCCESS SCHEMES

BRAND NEW BOOK 40,000 WORDS in TEXT!

SOLD ON A MONEY-BACK GUARANTEE!

In "CASH IN" you get ALL the real money-makers—dozens of profitable tested mail order plans, confidential business secrets, dozens of practical tested formulas, successful tested schemes—actual experiences of men who have started on a shoestring—with less than \$10 capital.

Buyers of This Book Tell Us—

"Biggest value I've yet to see. Book is worth at least a dollar." S. BUDA, H'klyn, N. Y.
 "Your book is as good if not better than others selling at \$1.00."
 GEORGE BRUNET, Montreal, Can.
 "CASH IN is the best value I have yet to see in the mail order field."
 LAWRENCE FOX, Brooklyn, N. Y.
 "CASH IN" contains only tested ideas covering every type of full-or spare-time enterprise—it's a "masterpiece" in business ventures.
 25 CENTS per copy. Sent POSTPAID anywhere upon receipt of 25 cents U.S. stamps or coin.
NATIONAL PLANS INSTITUTE
 246-R FIFTH AVENUE NEW YORK, N. Y.

DO NOT FAIL

to read the important announcement which appears on page 444 of this issue. It is important news to everyone who is in the radio business.

MICHIGAN AVENUE

WHERE CHICAGO Lives

● The pulse of the city — Michigan Avenue.
 Chicago works and plays to the tune of its rhythmic hum. In the most convenient location on this famous thoroughfare, Hotel Auditorium provides spacious pleasant rooms, excellent service and superb cuisine, at reasonable rates.

WITH BATH FROM \$2.50 WITHOUT BATH FROM \$1.50



MICHIGAN AT CONGRESS GEO. H. MINK, Manager

- One I.R.C. type B1 carbon resistor, 1,250 ohms, 1 W.;
- One I.R.C. type B1 carbon resistor, 1,500 ohms, 1 W.;
- One U.T.C. No. CS23 class B input transformer, 6A6 plates to two 6A6 grids;
- One U.T.C. No. CSR modulation transformer, 6A6 plates to 30,000 ohms;
- One Ohmite "Red Devil" resistor, 400 ohms, 10 W.;
- One Aerovox type 484 tubular condenser, 0.001-mf.;
- One National type R100 high-frequency R.F. choke;
- One Cardwell "Midway" type MR50BD split-stator condenser, 50 mmf. both sections;
- Three Sylvania type 6A6G tubes;
- One Eveready "Mazda" spotlight reflector and light bulb;
- One chassis and hardware;
- One power supply, 450 V., 100 ma.;
- Two 12-meter coils (see text).

RECEIVER

- One RCA PE. cell, No. 921;
- One Aerovox No. 450 condenser, 0.01-mf., C1;
- One Aerovox type 484 paper condenser, 1 mf., 400 V., C2;
- Two Aerovox type PB25 electrolytic condensers, 25 mf., 25 V., C3, C5;
- One Cornell-Dubilier electrolytic condenser, 8 mf., 200 V., C4;
- Two Aerovox type 484 tubular condensers, 0.1-mf., 400 V., C6, C9;
- One Aerovox type 484 tubular condenser, 0.003-mf., 400 V., C8;
- One Yaxley L potentiometer, 0.1-meg., R;
- Two I.R.C. B1 carbon resistors, 0.1-meg., 1 W., R1, R6;
- One I.R.C. B1 carbon resistor, 75,000 ohms, 1 W., R2;
- One I.R.C. B½ carbon resistor, 1 meg., ½-W., R3;
- One I.R.C. B½ carbon resistor, 5 megs., ½-W., R4;
- Two I.R.C. B1 carbon resistors, 2,250 ohms, 1 W., R5, R10;
- One I.R.C. B1 carbon resistor, 0.25-meg., 1 W., R7;
- One I.R.C. B1 carbon resistor, 20,000 ohms, 1 W., R8;
- Two Yaxley type M potentiometers, 0.25-meg., R9 (volume control), R12 (tone control);
- One I.R.C. B1 carbon resistor, 50,000 ohms, 1 W., R11;
- One ohmite "Red Devil" resistor, 200 ohms, 10 W., R13;
- Two Sylvania type 6J7 tubes;
- Two Sylvania type 6F6 tubes;
- One Thordarson tapped input choke, No. T7431;
- One Wright DeCoster permanent-magnet magnetic loudspeaker, with output transformer to 6F6's in push-push class B;
- One power supply, 250 V., 80 ma.

Feature Articles in the January Issue of "Radio & Television"

Television—Tomorrow's Big Opportunity, William Dubilier. Television in the Spring. H. W. Secor. A New Big "World-Wide Digest" Section—6 pages. Stolen Payroll Calls Police—by Radio. The "Mystery Control" and How It Works. The Radio Beginner—Martin Clifford. World Short-Wave Station List and "Listening Tips." Roster of "Newly Licensed" Hams. Increase Your DX with New Pre-Amplifier. Howard G. McEntee, W2FHP. A De Luxe "Desk Type" Transmitter, Alvin Abrams, W2DTT. A One-Tube "Bandspread" Receiver, Herman Yellin, W2AJL.

RADOLEK

EVERYTHING IN RADIO

1939
RADOLEK
 RADOLEK COMPANY
 601 W. RANDOLPH, CHICAGO

Everything in radio in this Big New 1939 RADOLEK PROFIT GUIDE. Radolek has everything under one roof. When you order, you get just what you want, promptly and economically. Over 25,000 Radio Servicemen now depend upon Radolek Service. Send for your copy of this big book. It will give you new ideas in conducting your service business on a more profitable basis.

Test Instruments—The most complete line ever displayed in any catalog. Latest improved models that provide every conceivable test necessary for thorough radio receiver analysis and repair. New push button tube testers that simplify and speed up testing time.

Over 12,000 Repair Parts, Tools, etc. Parts to repair any radio receiver made. All leading brands are represented. Every item guaranteed! And all at prices that SAVE YOU MONEY!

All Tubes Represented—RCA, Sylvania, Raytheon, Philco, etc. Includes Kellogg, special Majestic types and transmitting tubes.

Complete Public Address Display. New 1939 model public address amplifiers with outputs from 10 to 90 watts. Complete P. A. Systems for permanent, Mobile and Portable installations. Powerful beam power systems attractively designed and priced for greater profits.

Latest Radio Models. The super values of 1939. New Phono-Radio combinations. Automatic tuning sets with strikingly beautiful cabinets that harmonize with all home furnishings. Also new "Ham" receivers and TRANSMITTERS!

Complete Auto Radio Section. Includes vibrator replacement guide, new auto aerials at new low prices and custom panel control plates for all automobiles. And new Delco Auto Sets that are the easiest to sell with the greatest profits.

Send for **FREE** catalog

The RADOLEK Co.
 601 W. Randolph, Chicago, Dept. C-25

Send the Radolek Radio Profit Guide **FREE**.

Name

Address

Service man? Dealer? Experimenter?

Please Say That You Saw It in RADIO-CRAFT

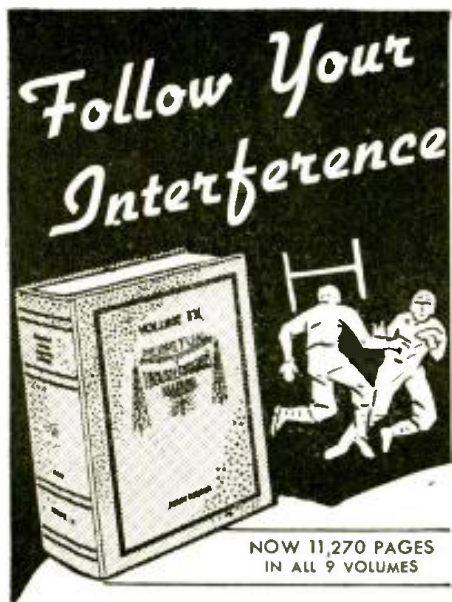

Follow Rider Manuals For Speedy-Profitable SERVICING

Rider Manuals "take out" the stiff opposition of today's complicated circuits. Stop tussling with baffling service problems! Push-button tuning, 24-hour time clock tuning, motor driven mechanisms, remote control units and other new and complicated features of the 1939 sets make it vital that you have the information provided by Volume IX. No profiting service technician can afford to be without all nine Rider Manuals.

JUST OFF PRESS RIDER MANUAL VOL. IX

- New** — 1650 pages of time-saving facts on 1938-39 receivers.
 - New** — 64-page 'How it Works' section. Time savina hints on complicated sets.
 - New** — 140-pages indexing and cross-indexing all nine Rider volumes.
- Volume IX, priced at \$10.00, contains the most authentic and comprehensive compilation of service data available in the industry — facts you need when servicing the newer, more complicated sets. You will eventually buy Vol. IX. Why wait! Get it today and start benefiting from this vast storehouse of essential circuit data.

JOHN F. RIDER, Publisher
404 Fourth Ave.,
New York City

DID YOU SAY 9?

YOU NEED ALL 9 Rider MANUALS

YES, I SAID 9!

THIS HOME—WIRED FOR RADIO

(Continued from page 445)

volume controls, more cable and other accessories. Radio dealers and jobbers who handle and distribute the merchandise of these manufacturers will turn over a handsome profit.

Servicemen will have a vast new field for their operations, for these radio remote control systems will not be so easy for the family handy-man to tinker with. Yet, for the Serviceman, it will be a cinch. For just as there are service manuals and diagrams of present receivers so will there be (and definitely should be) plans of the complete wiring of the entire system.

Builders and contractors will be benefited in that they will have another talking point, and a very attractive one, for their homes; and a point that is bound to lure additional people to their offices.

An aid in this connection is the use of signs properly publicizing the "Wired for Radio" home, just as Mezicks Homes is helping publicize the *Radio-Craft* Model Home (as illustrated on the cover and in the illustration at the top of page 396—*Editor*).

The wiring plans illustrated here and in subsequent installments are those for the "average American home." They will of course vary for individual homes, depending upon the size of the house, number of rooms, individual preferences as to locations of the remote units, etc. *Radio-Craft* will lend every assistance possible to any local Servicemen or organizations contracting to make a built-in radio installation.

CONCLUSION

Before concluding this first article there are 2 other novel features of this radio home we want to mention.

Number 1 is that a modern, melodious 4-tone chime system known as the "TELE-CHIME" Paging System will be incorporated. In addition to replacing the old-fashioned raucous door buzzers, the individual notes of the "TELECHIMES" will be wired as a *call system*. Thus a pushbutton near the telephone, will, when pressed, sound a single chime with pre-arranged frequency for summoning various members of the family to the telephone; a push-button in a convenient spot in the bathroom will quickly bring help in case of accidents or forgotten towels or slippers; a floor outlet will be provided in the dining room into which may be plugged a 4-note keyboard for playing dinner chimes to announce "soup's on"; a service entrance button will be connected to another single chime, and so on. The entire system is so flexible that practically any arrangement suitable to any particular family can be made. Incidentally, the main entrance button plays all 4 chimes—each time in a different harmonious sequence.

Number 2 is that all the house light switches will be of the new General Electric mercury type; the usual audible click in turning the toggle switch is gone as is the wearing of contacts and frequent replacement. These mercury switches are lifetime affairs and eliminate all danger of sparking in open air which as we all know is a fire hazard.

Part II of this series of articles will discuss the preliminary work of installation, making and mounting the speaker supports, locating the various remote units, running the cables inside the walls, etc.

Comments on this new plan will be gratefully received. Please address them to the attention of the writer.

Index to advertisers

A	
Aerovox Corporation.....	439
Allied Radio Corporation.....	431
American Microphone Company.....	425
American Television Institute, Inc.....	Back Cover
Amperite Corporation.....	424
Amplifier Co. of America.....	436
Arcturus Radio Tube Company.....	439
Arrow Sales Company.....	434
Auditorium Hotel.....	447
B	
Herman J. Bernard.....	Inside Back Cover
Browning Laboratories, Inc.....	438
Brush Development Company.....	429
Burstein-Applebee Company.....	432
C	
Capitol Radio Engineering Institute.....	432, 434
Central Radio Laboratories.....	443
Classified Section.....	438, 439
Cornell-Dubilier Electric Corporation.....	424
Coyne Electrical School.....	387
H	
Hammarlund Mfg. Company.....	427
Howard Radio Corporation.....	388
Hygrade Sylvania Corporation.....	434
I	
International Correspondence Schools.....	434
L	
Lancaster, Allwine & Rommel.....	438
Lincoln Engineering School.....	436
M	
John Meck Instruments.....	433
Miles Reproducer Company.....	441
Modell's.....	438
N	
National Plans Institute.....	447
National Radio Institute.....	385
National Schools.....	438
National Union Radio Corp.....	443
New York Radio Supply Co.....	434
New York YMCA Schools.....	438
R	
Radio & Technical Publ. Co.....	416A
Radio Circular Company.....	436
Radio City Products Company.....	426
Radio Publications.....	446
Radio Servicemen of America, Inc.....	428
Radolek Company.....	447
Ralston Record Company.....	427
RCA Institutes, Inc.....	441
RCA Mfg. Co., Inc.....	Insert
Readrite Meter Works.....	446
Remington Rand, Inc.....	436
John F. Rider.....	448
S	
Service Instruments, Inc.....	429
Solar Mfg. Company.....	429
Sprague Products Company.....	430
Sprayberry Academy of Radio.....	416B
Superior Instruments Company.....	423
Supreme Instruments Corporation.....	425
T	
Technifax.....	426
Teletran Products Company.....	438
Test Equipment Co. of America.....	443
Triplett Elect. Instrument Co.....	437
U	
United Radio Company.....	427
Montgomery Ward & Company.....	441
W	
Wellworth Trading Company.....	430, 432
Weston Elect. Instrument Corp.....	Inside Front Cover
Wholesale Radio Service Co., Inc.....	435
Wright-DeCoster, Inc.....	445

(While every precaution is taken to insure accuracy, we cannot guarantee against the possibility of an occasional change or omission in the preparation of this index.)

Please Say That You Saw It in RADIO-CRAFT

BERNARD *Quality* Test Units

WORLD'S LOWEST INSTRUMENT PRICES!

ALL INSTRUMENTS HANDSOMELY FINISHED AND HOUSED IN SOLID WOOD CABINETS

PORTABLE ANALYZER
5,000 OHMS
PER VOLT **\$29⁹⁰**



33 RANGES

MAXIMETER, with 4 1/2" square d'Arsonval 0-200 microammeter, provides the first complete set of ranges ever offered. D.C. ranges are at **5,000 OHMS PER VOLT, A.C.** at 1,200 ohms per volt, including output meter range. All batteries self-contained. 2,500-volt D.C. range makes instrument available to servicing television receivers, amateur transmitters and oscilloscopes.

0-10-50-250-500-2,500 volts D.C., all at 5,000 ohms per volt
0-1-10-100-1,000 ma. (one amb.) D.C.
0-3,000 ohms (20 ohms center) distance between 0 and 1 ohm 3/16 inch; 0-30,000, 300,000, 3,000,000 and 30,000,000 ohms.
Separate position for 300 v. supply to read 300,000,000 ohms
0-15-150 volts A.C. output meter condenser self-contained.
0-15-150-1,500 volts A.C.
Minus 10 to plus 58 DB in 3 ranges (.0005-.05 mfd.) (.005-.5 mfd.) (.05-50 mfd.)
14-14 hours (1,1-140) (1-14,000 henries)
0-150 watts for A.C. D.C. 0-1-3 amperes A.C.
Model 384 Master Micro-Multimeter, the **BERNARD MAXIMETER**; shipping weight 12 lbs.

PUSH-BUTTON TUBE TESTER **\$20⁹⁰**
for Checking All Type Tubes

AN up-to-the-minute push-button tube tester and tube seller for direct readings on all tubes, both metal and glass, whether A.C. or battery types. **TUBOMETER** tests for quality, individual element leakage (both hot and cold); shorts, opens, noise and gas, all in accordance with highest engineering standards for emission testers.

A fine voltage control is included. Individual switch control of all elements takes care of "floating elements" and other non-standard tube arrangements. EXTRA socket facilities and other ample provisions guard against obsolescence.

Fast, accurate, simple, the Bernard Tube Tester uses no adapters.

Large 1 1/2" square illuminated meter, with provision for external use of the meter alone (0-1 ma.)

Tests include all the old tubes, also all the new tubes, among them the new television tubes, e.g., 1851; the 1-4-volt 50 ma. and other battery tubes; gas tubes, such as 2A1G, 0A1G, 8K1; ballasts, magic eyes, etc.

The impressive appearance inspires customer confidence; the rugged construction assures dependable service and long life. Removable cover distinguishes the model (387) for portable use. Complete model (387-C) costs \$1.00 less, or \$19.90.

Portable Tubometer is equipped with handy (see chart) BERNARD super-accuracy terminals throughout. Model 387 or 387-C, shipping weight, 11 lbs.



POCKET MULTIMETER **\$8⁹⁰**
1,000 OHMS PER VOLT

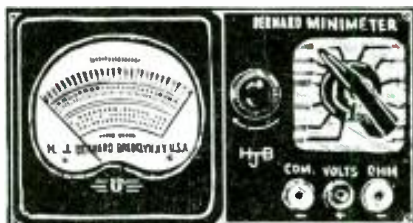

13 RANGES

MINIMETER (Model 388-J) is the outstanding 1,000-ohm per volt value. It has the same precision as the other fine BERNARD Multimeters. A 3" d'Arsonval movement meter has large-lettered scale that affords clear reading.

0-10-50-250-500-2,500 volts D.C., all at 1,000 ohms per volt.
0-10-100-1,000 milliamperes (one ampere maximum).
0-500-250,000 ohms with small self-contained 3-v. battery. 10c renewal cost.
0-15-150-1,500 volts A.C., practically linear scale.

MINIATURE MICRO-MULTIMETER
14 Ranges **\$13⁹⁰**
5,000 OHMS PER VOLT

THE Deluxe Model **METERETTE** (Model 381-S) is the outstanding 5,000-ohms-per-volter, providing super-accuracy and durability at lowest price. This model is housed in a closed box of three-coat finished solid instrument wood, with removable hinged cover and compartment for the supplied test leads. **METERETTE** is the first combination of super-accuracy, high sensitivity and low cost in a universal multimeter. A 3" square meter, with d'Arsonval movement, is used. Like all BERNARD MULTIMETERS, it has only two controls, instead of the usual three, and separate selector switch positions for A.C., separate one for D.C. The 3 volt battery (the removal cost) is self-contained.

0-10-50-250-500-2,500 volts D.C. all at 5,000 ohms per volt.
0-10-100-1,000 milliamperes D.C. Also 0-200 microamperes D.C.
0-2,000 and 1,000-2,000,000 ohms.
0-10-100-1,000 volts A.C. at 1,200 ohms per volt.

GIANT ANALYZER
WITH REMOTE CONTROL **\$29⁹⁰**



8 5/8" Diameter

1,000 OHMS PER VOLT

Giant MULTIMETER with remote control box, same ranges as MAXIMETER but using 8 5/8" meter, 1,000 ohms per volt D.C. with 2.5 meg. limit. Model 388 BERNARD ATLAS. Shipping weight 6 lbs.

TELEVISION SIGNAL GENERATOR **\$19⁹⁰**

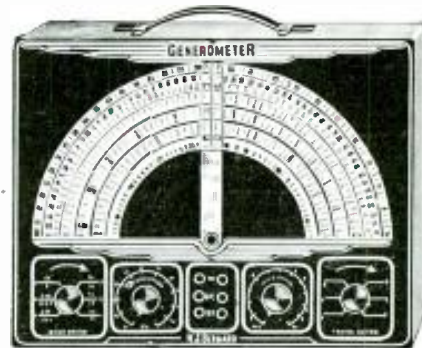

6 RANGES

Having an outstanding dial—ELEVEN INCHES in diameter, **Generometer**, the famous BERNARD SIGNAL GENERATOR (model 382) has an attenuator effective on all six bands, 120 kc. to 70 mc., or down to 13 meters, including television bands. For 50-60 cycle 90-135 volt A.C. In steel cabinet not wood.

SUPER ACCURACY

BERNARD INSTRUMENTS are the first and only highly accurate ones in the low-priced field.

Lowest Priced But Priceless
BERNARD

319-G THIRD AVENUE

BROOKLYN, N. Y.

Export Representative: Pan-Mar Corporation, 1270 Broadway, New York, N. Y.

SEND FOR CATALOG "G"

FULLY GUARANTEED

Ours are the only instruments in the lowest priced field supplied with printed guarantee.

\$50, \$75, \$100 A WEEK IN TELEVISION?

Yes!
IT'S NOW
BEING DONE!

ASSOCIATE LEWIS HOSKINS
EARNS \$10,000 IN TEN MONTHS
WITH HIS
A.T.I. EQUIPMENT!



READ
HIS INSPIRING
MESSAGE TO
YOU! →

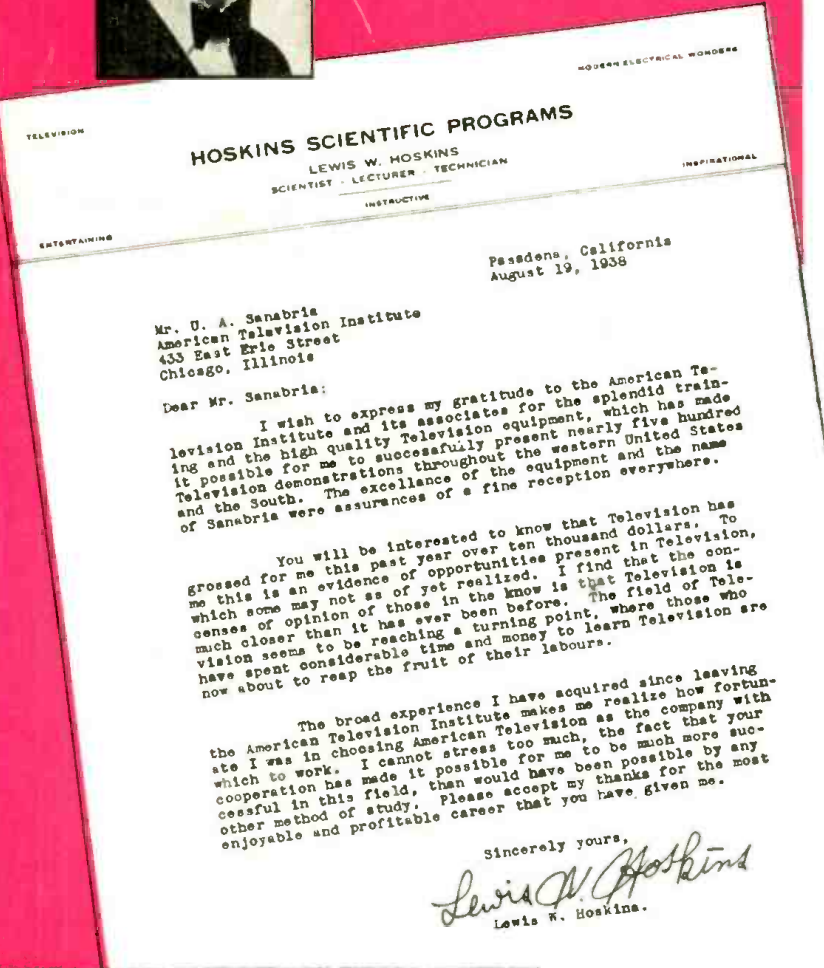

A.T.I. ASSOCIATES ARE
Making Big Money
WITH THEIR A.T.I.
**DOUBLE ELECTRONIC
TELEVISION UNITS**
AND
**A.T.I.'S PROFITABLE EXCLUSIVE
TELEVISION DEMONSTRATION PLAN**

Using the Television Equipment they received from the American Television Institute, many Associates of A.T.I. are ALREADY turning their television training to profit. Through their prepared Television demonstrations, these men are now making more money than they ever imagined. An outstanding example is Lewis W. Hoskins whose remarkable success is clearly evident in the letter shown. This is just one of the many recent successes of A.T.I. men in the Television field.

Get In On The Ground Floor NOW!

There are thousands of locations where Television demonstrators will be received with enthusiasm. Thousands of organizations, schools, clubs, theatres and businesses that can use Television exhibitions for educational, publicity and advertising purposes. With A.T.I. training and equipment you can make big money giving Television to them. BUT, DON'T WAIT. START NOW!

Write For Complete Details!

Get all the facts on how A.T.I. Television Training prepares you for good pay jobs as, Radio Station Operator, Service Man, Laboratory-Factory Technician, Sales Engineer, Sound Camera Technician, and many fascinating other branches. See how A.T.I. Booking-Employment Service prepares you, equips you and places you in business. The illustration shows the Television Transmitting Unit and Receiver-Oscilloscope sections of the professional Television Equipment which is included along with other scientific television apparatus in your training... at NO EXTRA COST! Easy payment plan. It costs nothing to investigate. This may be the greatest opportunity of your life. SEND COUPON NOW!



AMERICAN TELEVISION INSTITUTE

433 E. Erie St., Dept. RC-139, Chicago, Ill.

Gentlemen: Please send me your free book on Television and literature describing A.T.I. Training Plan, designed to completely equip me for making real money in Television. No obligation in any way.

Name Age.....
Address
City State.....

**MAIL
COUPON
NOW!**